



Description

N-channel Enhancement Mode Power MOSFET

Features

- 20V, 50A
 $R_{DS(ON)} < 8m\Omega @ V_{GS} = 4.5V$
 $R_{DS(ON)} < 13m\Omega @ V_{GS} = 2.5V$
- Advanced Trench Technology
- Excellent $R_{DS(ON)}$ and Low Gate Charge
- Lead free product is acquired

Application

- Load Switch
- PWM Application
- Power management



100% UIS TESTED!
100% ΔVds TESTED!

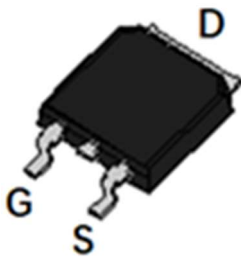

TO-252-4R(DPAK) top view

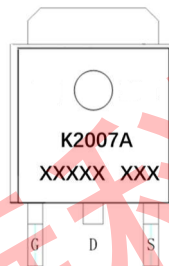

Marking and pin Assignment

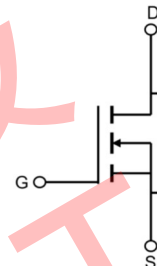

Schematic Diagram

Package Marking and Ordering Information

| Device Marking | Device | OUTLINE | Device Package | Reel Size | Reel (PCS) | Per Carton (PCS) |
|----------------|-----------|---------|----------------|-----------|------------|------------------|
| JMTK2007A | JMTK2007A | TAPING | TO-252-4R | 13inch | 2500 | 25000 |

Absolute Maximum Ratings (T_C=25°C unless otherwise specified)

| Symbol | Parameter | Max. | Units |
|-----------------------------------|---|------------------------|---------|
| V _{DSS} | Drain-Source Voltage | 20 | V |
| V _{GSS} | Gate-Source Voltage | ±12 | V |
| I _D | Continuous Drain Current | T _C = 25°C | 50 A |
| | | T _C = 100°C | 33 A |
| I _{DM} | Pulsed Drain Current ^{note1} | 200 | A |
| E _{AS} | Single Pulsed Avalanche Energy ^{note2} | 36 | mJ |
| P _D | Power Dissipation | T _C = 25°C | 31 W |
| R _{θJC} | Thermal Resistance, Junction to Case | 4.84 | °C/W |
| T _J , T _{STG} | Operating and Storage Temperature Range | -55 to +175 | °C |



Electrical Characteristics ($T_J=25^\circ\text{C}$ unless otherwise specified)

| Symbol | Parameter | Test Condition | Min. | Typ. | Max. | Units |
|---|---|---|------|------|-----------|------------|
| Off Characteristic | | | | | | |
| $V_{(BR)DSS}$ | Drain-Source Breakdown Voltage | $V_{GS}=0V, I_D=250\mu A$ | 20 | - | - | V |
| I_{DSS} | Zero Gate Voltage Drain Current | $V_{DS}=20V, V_{GS}=0V,$ | - | - | 1.0 | μA |
| I_{GSS} | Gate to Body Leakage Current | $V_{DS}=0V, V_{GS}=\pm 12V$ | - | - | ± 100 | nA |
| On Characteristics | | | | | | |
| $V_{GS(th)}$ | Gate Threshold Voltage | $V_{DS}=V_{GS}, I_D=250\mu A$ | 0.4 | 0.7 | 1.1 | V |
| $R_{DS(on)}$ | Static Drain-Source on-Resistance <small>note3</small> | $V_{GS}=4.5V, I_D=25A$ | - | 6.3 | 8.0 | m Ω |
| | | $V_{GS}=2.5V, I_D=10A$ | - | 8.8 | 13 | |
| Dynamic Characteristics | | | | | | |
| C_{iss} | Input Capacitance | $V_{DS}=10V, V_{GS}=0V,$ $f=1.0MHz$ | - | 1458 | - | pF |
| C_{oss} | Output Capacitance | | - | 238 | - | pF |
| C_{rss} | Reverse Transfer Capacitance | | - | 212 | - | pF |
| Q_g | Total Gate Charge | $V_{DS}=10V, I_D=25A,$ $V_{GS}=4.5V$ | - | 19 | - | nC |
| Q_{gs} | Gate-Source Charge | | - | 3 | - | nC |
| Q_{gd} | Gate-Drain("Miller") Charge | | - | 6.4 | - | nC |
| Switching Characteristics | | | | | | |
| $t_{d(on)}$ | Turn-on Delay Time | $V_{DS}=10V,$ $I_D=10A, R_{GEN}=3\Omega,$ $V_{GS}=4.5V$ | - | 10 | - | ns |
| t_r | Turn-on Rise Time | | - | 21 | - | ns |
| $t_{d(off)}$ | Turn-off Delay Time | | - | 39 | - | ns |
| t_f | Turn-off Fall Time | | - | 19 | - | ns |
| Drain-Source Diode Characteristics and Maximum Ratings | | | | | | |
| I_S | Maximum Continuous Drain to Source Diode Forward Current | | - | - | 50 | A |
| I_{SM} | Maximum Pulsed Drain to Source Diode Forward Current | | - | - | 200 | A |
| V_{SD} | Drain to Source Diode Forward Voltage | $V_{GS}=0V, I_S=30A$ | - | - | 1.2 | V |
| t_{rr} | Body Diode Reverse Recovery Time | $I_F=20A, di/dt=100A/\mu s$ | - | 25 | - | ns |
| Q_{rr} | Body Diode Reverse Recovery Charge | | - | 20 | - | nC |

Notes:1. Repetitive Rating: Pulse Width Limited by Maximum Junction Temperature

2. EAS condition: $T_J=25^\circ\text{C}$, $V_{DD}=10V$, $V_G=4.5V$, $L=0.5mH$, $R_G=25\Omega$, $I_{AS}=12A$

3. Pulse Test: Pulse Width $\leq 300\mu s$, Duty Cycle $\leq 0.5\%$



Typical Performance Characteristics

Figure 1: Output Characteristics

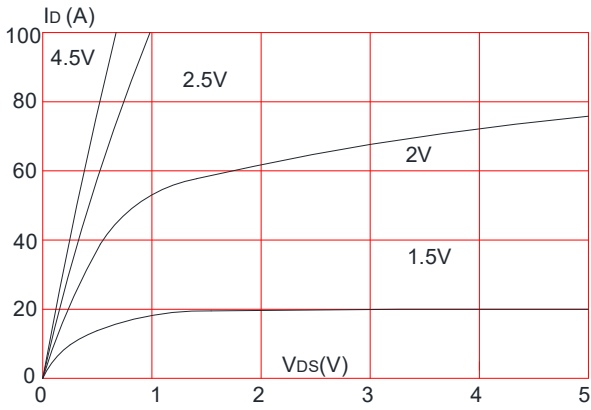

Figure 2: Typical Transfer Characteristics

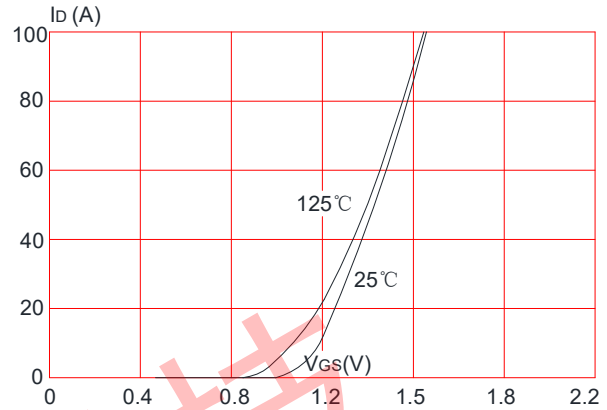

Figure 3: On-resistance vs. Drain Current

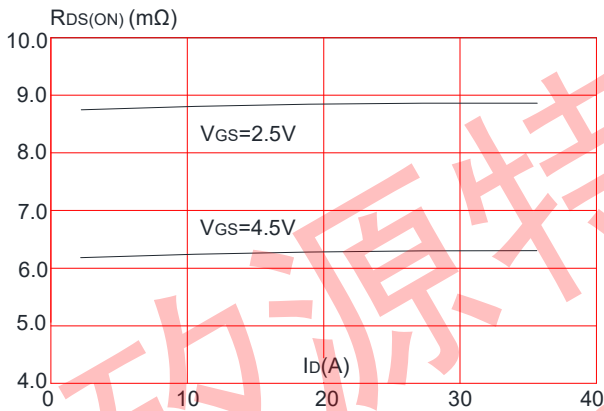

Figure 4: Body Diode Characteristics

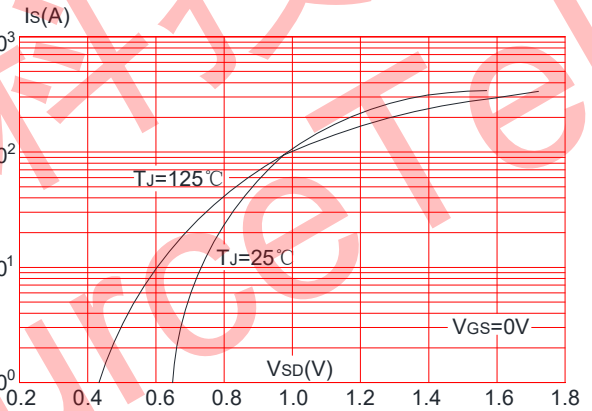

Figure 5: Gate Charge Characteristics

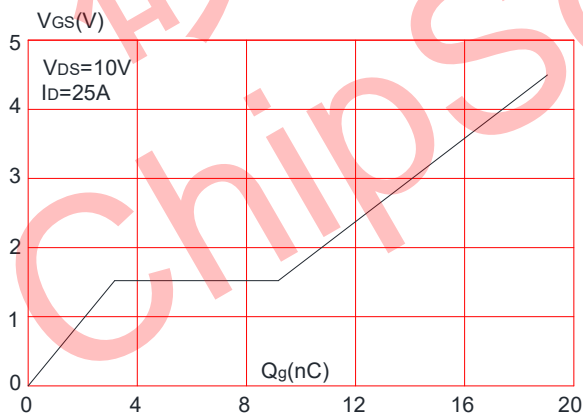

Figure 6: Capacitance Characteristics

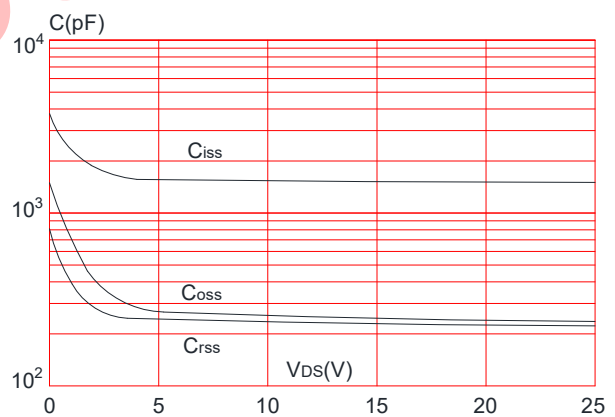



Figure 7: Normalized Breakdown Voltage vs. Junction Temperature

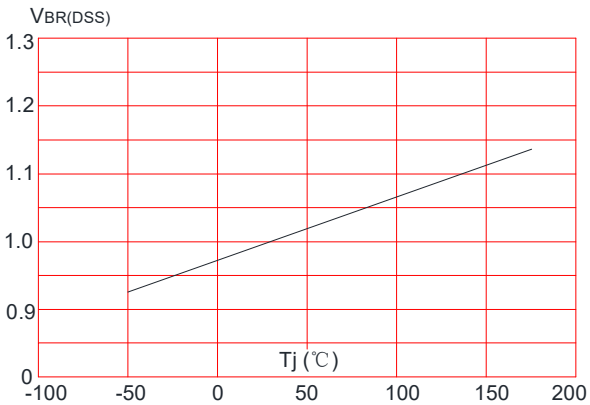

Figure 8: Normalized on Resistance vs. Junction Temperature

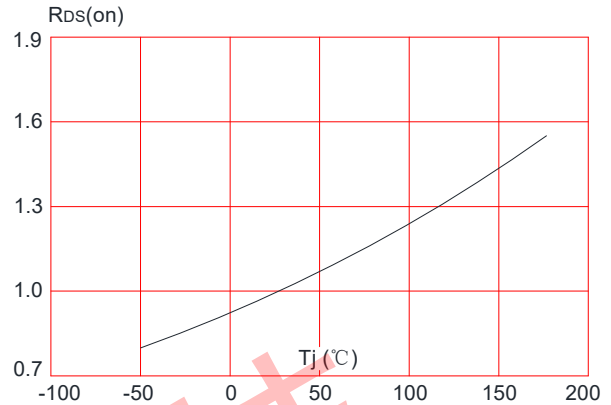

Figure 9: Maximum Safe Operating Area

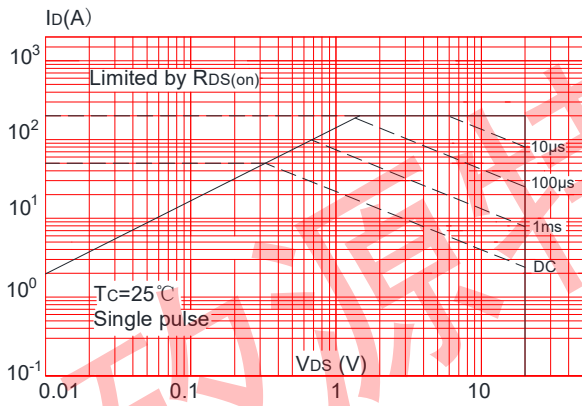

Figure 10: Maximum Continuous Drain Current vs. Case Temperature

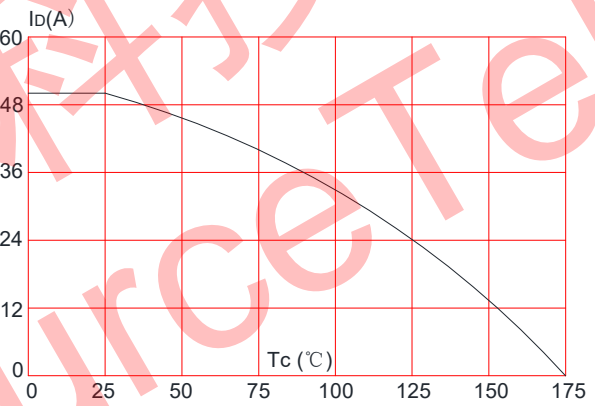
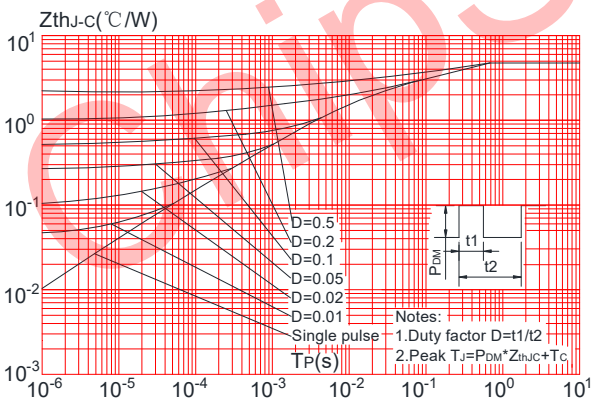

Figure 11: Maximum Effective Transient Thermal Impedance, Junction-to-Case





Test Circuit

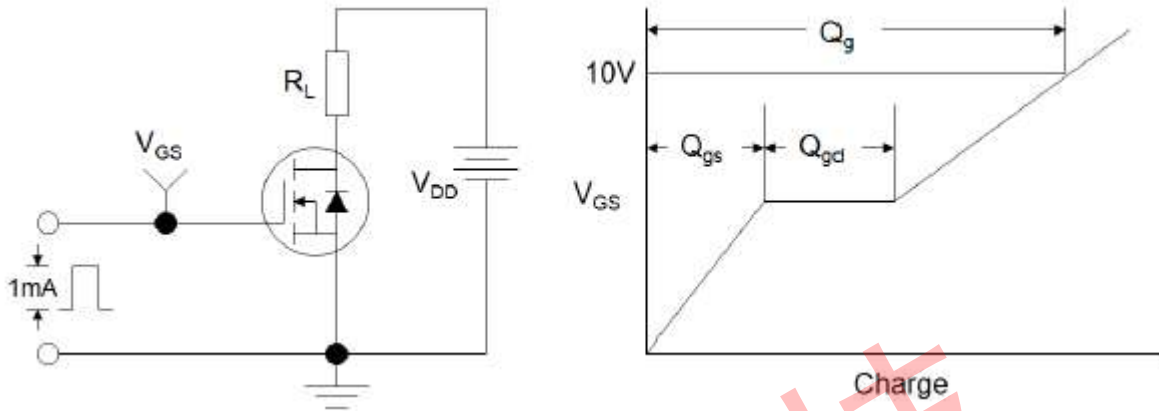

Figure1:Gate Charge Test Circuit & Waveform

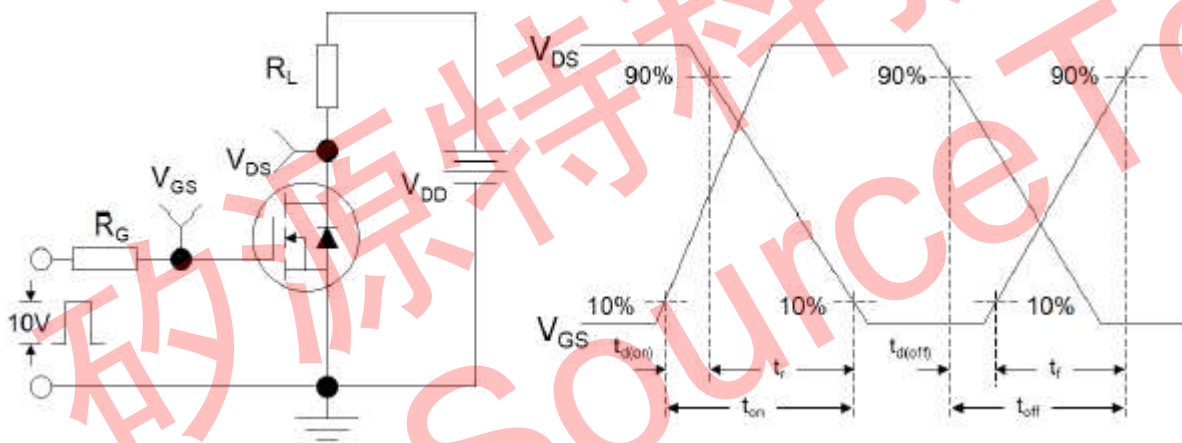

Figure 2: Resistive Switching Test Circuit & Waveforms

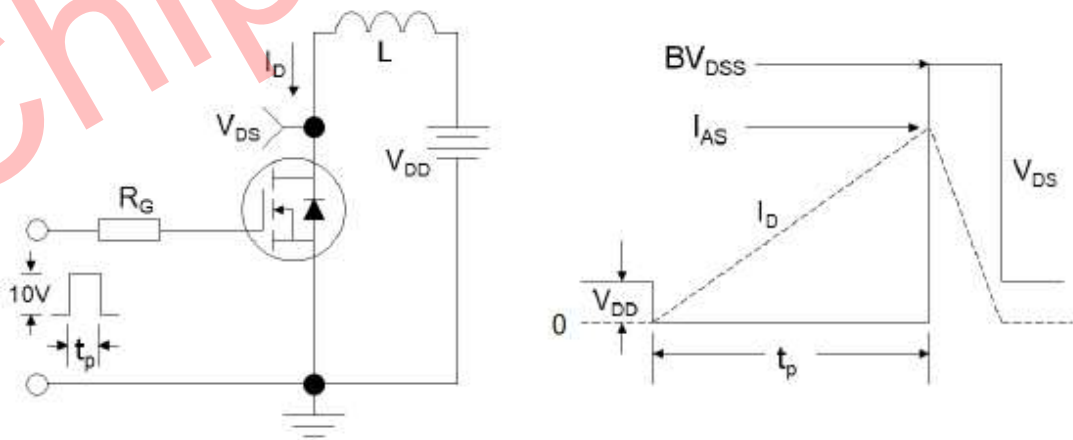
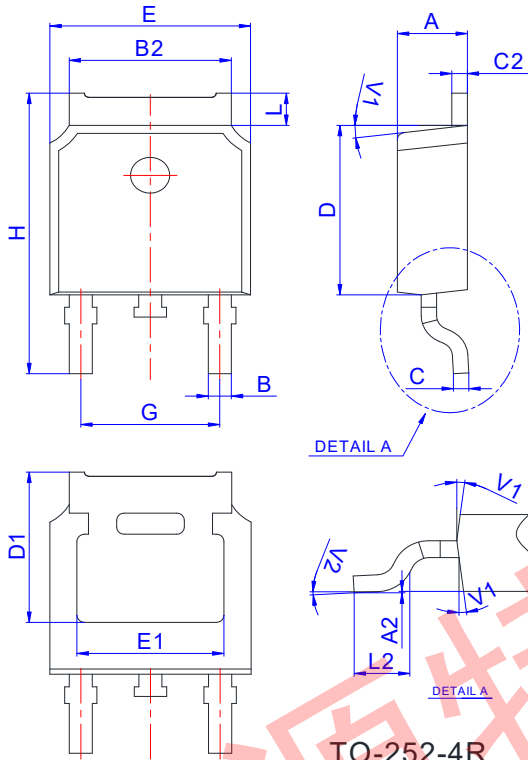

Figure 3:Unclamped Inductive Switching Test Circuit & Waveforms



Package Mechanical Data-TO-252-4R



| Ref. | Dimensions | | | | | |
|------|-------------|------|-------|----------|------|-------|
| | Millimeters | | | Inches | | |
| | Min. | Typ. | Max. | Min. | Typ. | Max. |
| A | 2.10 | | 2.50 | 0.083 | | 0.098 |
| A2 | 0 | | 0.10 | 0 | | 0.004 |
| B | 0.66 | | 0.86 | 0.026 | | 0.034 |
| B2 | 5.18 | | 5.48 | 0.202 | | 0.216 |
| C | 0.40 | | 0.60 | 0.016 | | 0.024 |
| C2 | 0.44 | | 0.58 | 0.017 | | 0.023 |
| D | 5.90 | | 6.30 | 0.232 | | 0.248 |
| D1 | 5.30REF | | | 0.209REF | | |
| E | 6.40 | | 6.80 | 0.252 | | 0.268 |
| E1 | 4.63 | | | 0.182 | | |
| G | 4.47 | | 4.67 | 0.176 | | 0.184 |
| H | 9.50 | | 10.70 | 0.374 | | 0.421 |
| L | 1.09 | | 1.21 | 0.043 | | 0.048 |
| L2 | 1.35 | | 1.65 | 0.053 | | 0.065 |
| V1 | | 7° | | | 7° | |
| V2 | 0° | | 6° | 0° | | 6° |

Reel Specification-TO-252

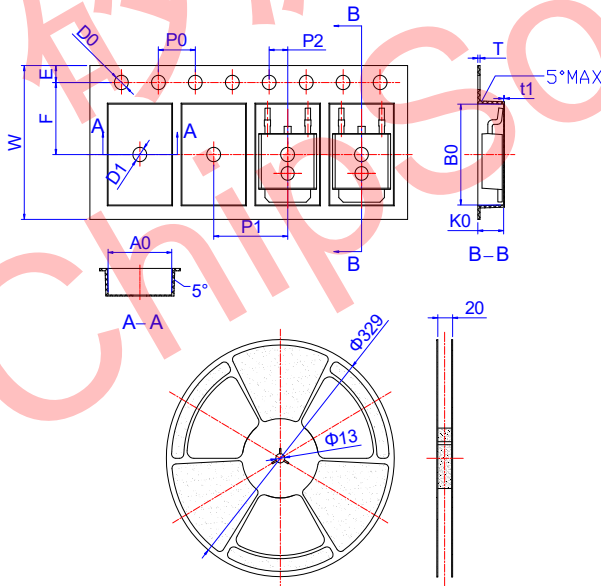

| Ref. | Dimensions | | | | | |
|------|-------------|-------|-------|--------|-------|-------|
| | Millimeters | | | Inches | | |
| | Min. | Typ. | Max. | Min. | Typ. | Max. |
| W | 15.90 | 16.00 | 16.10 | 0.626 | 0.630 | 0.634 |
| E | 1.65 | 1.75 | 1.85 | 0.065 | 0.069 | 0.073 |
| F | 7.40 | 7.50 | 7.60 | 0.291 | 0.295 | 0.299 |
| D0 | 1.40 | 1.50 | 1.60 | 0.055 | 0.059 | 0.063 |
| D1 | 1.40 | 1.50 | 1.60 | 0.055 | 0.059 | 0.063 |
| P0 | 3.90 | 4.00 | 4.10 | 0.154 | 0.157 | 0.161 |
| P1 | 7.90 | 8.00 | 8.10 | 0.311 | 0.315 | 0.319 |
| P2 | 1.90 | 2.00 | 2.10 | 0.075 | 0.079 | 0.083 |
| A0 | 6.85 | 6.90 | 7.00 | 0.270 | 0.271 | 0.276 |
| B0 | 10.45 | 10.50 | 10.60 | 0.411 | 0.413 | 0.417 |
| K0 | 2.68 | 2.78 | 2.88 | 0.105 | 0.109 | 0.113 |
| T | 0.24 | | 0.27 | 0.009 | | 0.011 |
| t1 | 0.10 | | | 0.004 | | |
| 10P0 | 39.80 | 40.00 | 40.20 | 1.567 | 1.575 | 1.583 |