

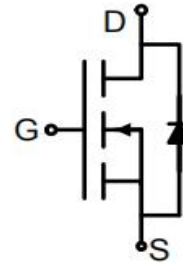

N-Channel Enhancement Mode Power MOSFET

Description

The MX4468 uses advanced trench technology and design to provide excellent $R_{DS(ON)}$ with low gate charge. It can be used in a wide variety of applications.



Schematic diagram

General Features

- ◆ $V_{DS} = 30V$, $I_D = 10A$
- ◆ $R_{DS(ON)}(Typ.) < 8m\Omega @ V_{GS} = 10V$
- ◆ $R_{DS(ON)}(Typ.) < 11m\Omega @ V_{GS} = 4.5V$
- ◆ High density cell design for ultra low R_{Dson}
- ◆ Fully characterized Avalanche voltage and current

Application

Power switching application
Hard Switched and High Frequency Circuits
Uninterruptible Power Supply

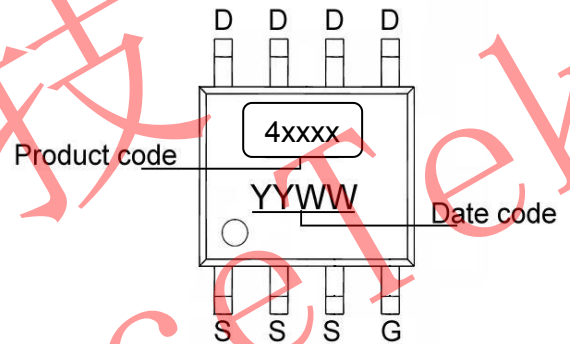

Marking and pin assignment

Absolute Maximum Ratings ($T_A = 25^\circ C$ unless otherwise noted)

Parameter	Symbol	Limit	Unit
Drain-Source Voltage	V_{DS}	30	V
Gate-Source Voltage	V_{GS}	± 20	V
Drain Current-Continuous	I_D	10	A
Drain Current-Continuous($T_C = 100^\circ C$)	$I_D(100^\circ C)$	6	A
Pulsed Drain Current	I_{DM}	50	A
Maximum Power Dissipation	P_D	2.5	W
Operating Junction and Storage Temperature Range	T_J, T_{STG}	-55 To 150	$^\circ C$



Electrical Characteristics (TA=25°C unless otherwise noted)

Parameter	Symbol	Condition	Min	Typ	Max	Unit
Off Characteristics						
Drain-Source Breakdown Voltage	BV _{DSS}	V _{GS} =0V, I _D =250μA	30	33	-	V
Zero Gate Voltage Drain Current	I _{DSS}	V _{DS} =30V, V _{GS} =0V	-	-	1	μA
Gate-Body Leakage Current	I _{GSS}	V _{GS} =±20V, V _{DS} =0V	-	-	±100	nA
On Characteristics (Note 3)						
Gate Threshold Voltage	V _{GS(th)}	V _{DS} =V _{GS} , I _D =250μA	1	1.6	3	V
Drain-Source On-State Resistance	R _{DS(ON)}	V _{GS} =10V, I _D =10A	-	8	12	mΩ
		V _{GS} =4.5V, I _D =5A	-	11	16	
Forward Transconductance	g _{FS}	V _{DS} =5V, I _D =10A	15	-	-	S
Dynamic Characteristics (Note4)						
Input Capacitance	C _{iss}	V _{DS} =15V, V _{GS} =0V, F=1.0MHz	-	1550	-	PF
Output Capacitance	C _{oss}		-	300	-	PF
Reverse Transfer Capacitance	C _{rss}		-	180	-	PF
Switching Characteristics (Note 4)						
Turn-on Delay Time	t _{d(on)}	V _{DD} =25V, I _D =1A V _{GS} =10V, R _{GEN} =6Ω	-	30	-	nS
Turn-on Rise Time	t _r		-	20	-	nS
Turn-Off Delay Time	t _{d(off)}		-	100	-	nS
Turn-Off Fall Time	t _f		-	80	-	nS
Total Gate Charge	Q _g	V _{DS} =15V, I _D =10A, V _{GS} =5V	-	13	-	nC
Gate-Source Charge	Q _{gs}		-	5.5	-	nC
Gate-Drain Charge	Q _{gd}		-	3.5	-	nC
Drain-Source Diode Characteristics						
Diode Forward Voltage (Note 3)	V _{SD}	V _{GS} =0V, I _S =10A	-	-	1.2	V
Diode Forward Current (Note 2)	I _S		-	-	10	A

Notes:

1. Repetitive Rating: Pulse width limited by maximum junction temperature.
2. Surface Mounted on FR4 Board, t ≤ 10 sec.
3. Pulse Test: Pulse Width ≤ 300μs, Duty Cycle ≤ 2%.
4. Guaranteed by design, not subject to production



Test Circuit

1) EAS Test Circuits

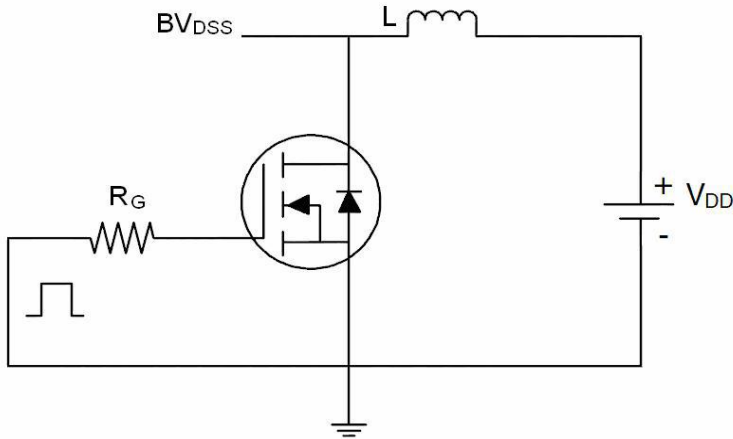

2) Gate Charge Test Circuit:

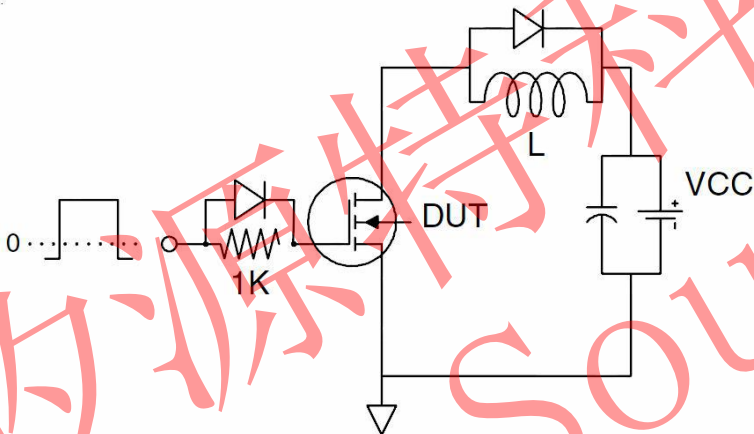

3) Switch Time Test Circuit:

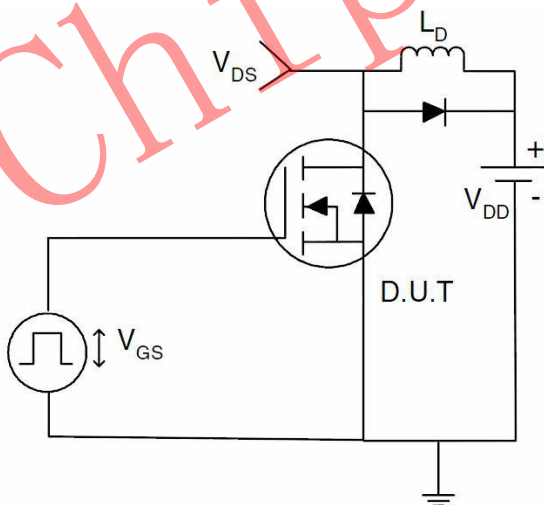



Typical Electrical and Thermal Characteristics (Curves)

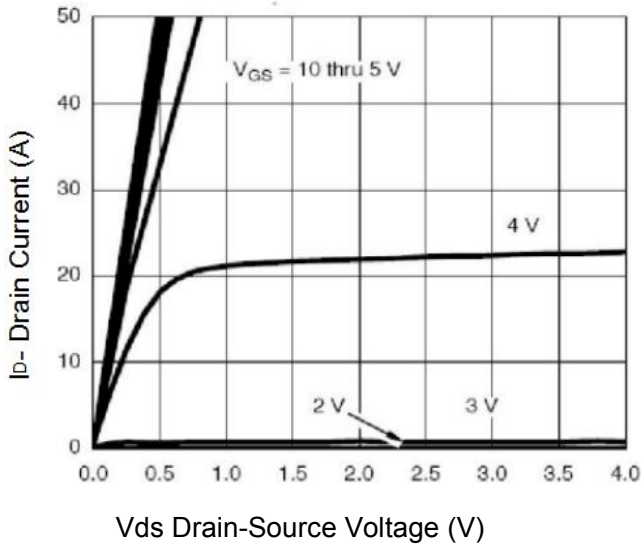

Figure 1 Output Characteristics

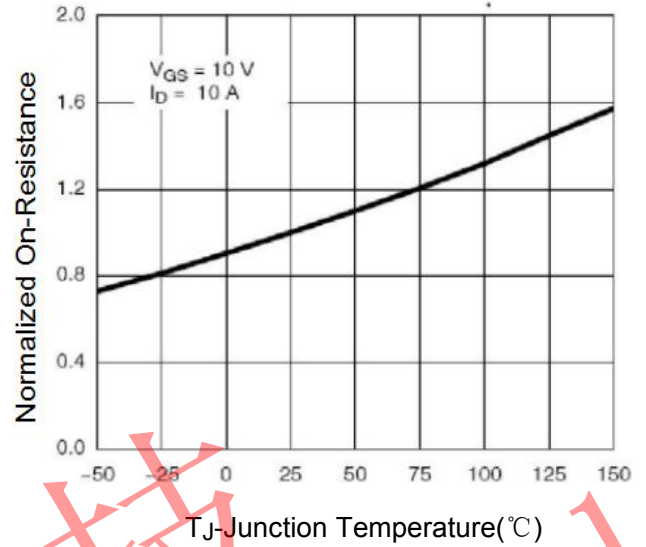

Figure 4 Rds(on)-Junction Temperature

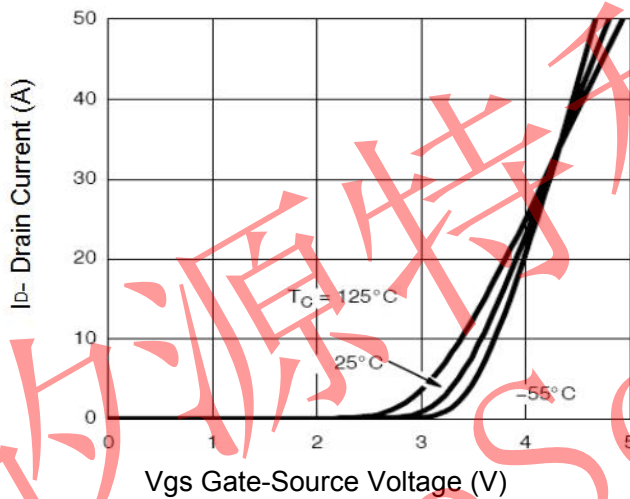

Figure 2 Transfer Characteristics

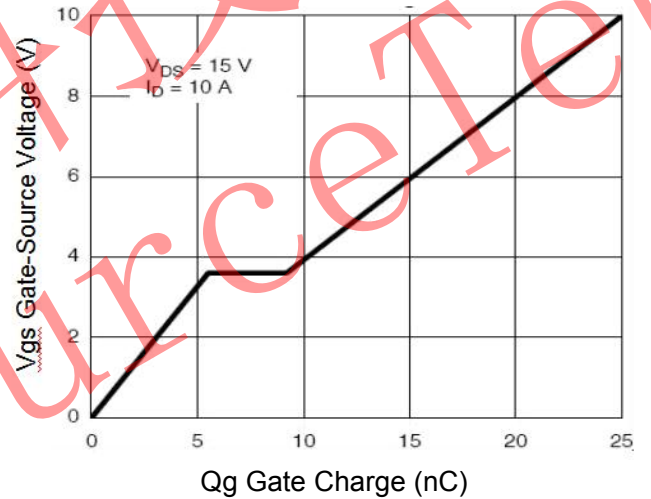

Figure 5 Gate Charge

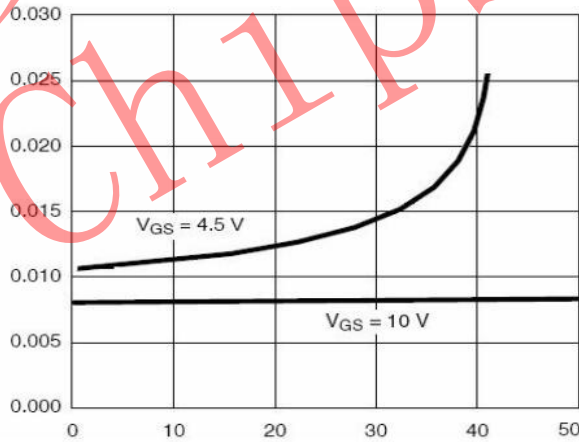

Figure 3 Rds(on)- Drain Current

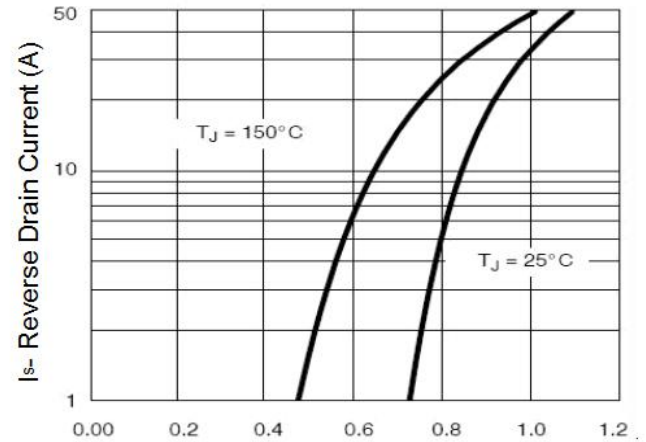
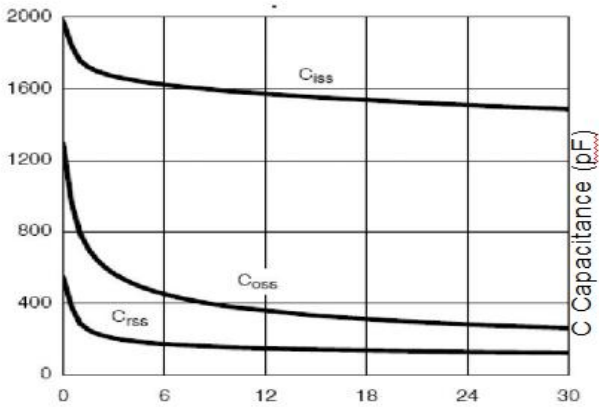
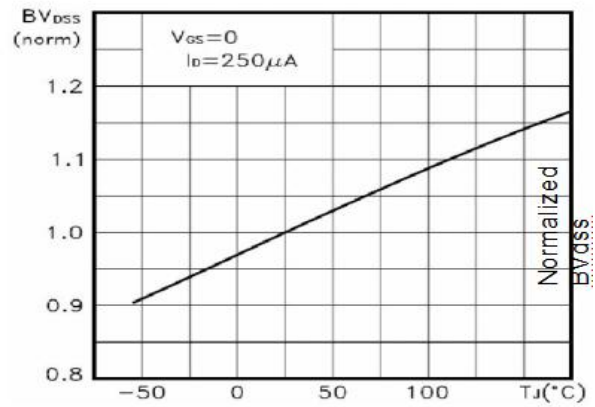

Figure 6 Source- Drain Diode Forward



Vds Drain-Source Voltage (V)

Figure 7 Capacitance vs Vds



TJ-Junction Temperature(°C)

Figure 9 BV_{DSS} vs Junction Temperature

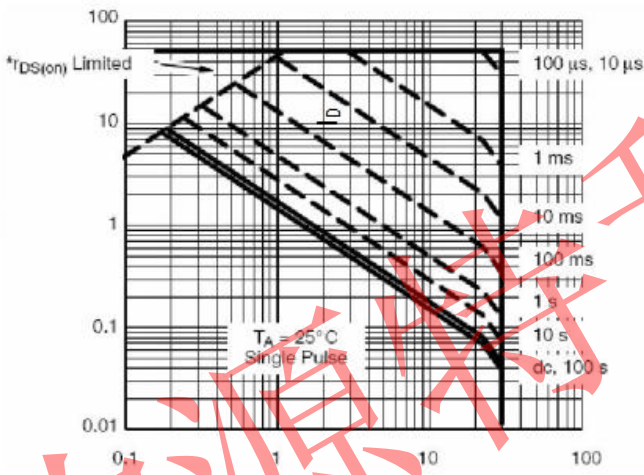

Vds Drain-Source Voltage (V)

Figure 8 Safe Operation Area

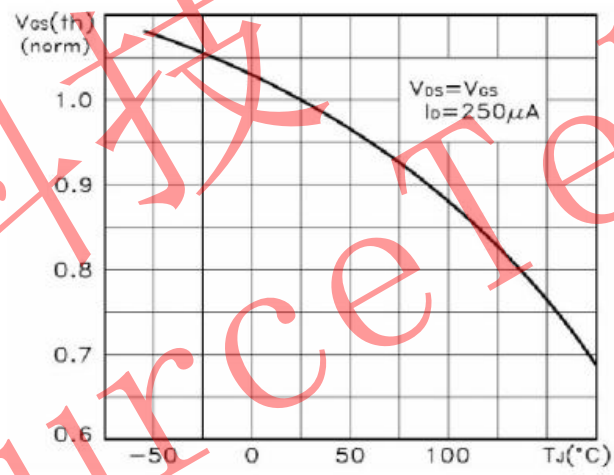

TJ-Junction Temperature(°C)

Figure 10 V_{GS(th)} vs Junction Temperature

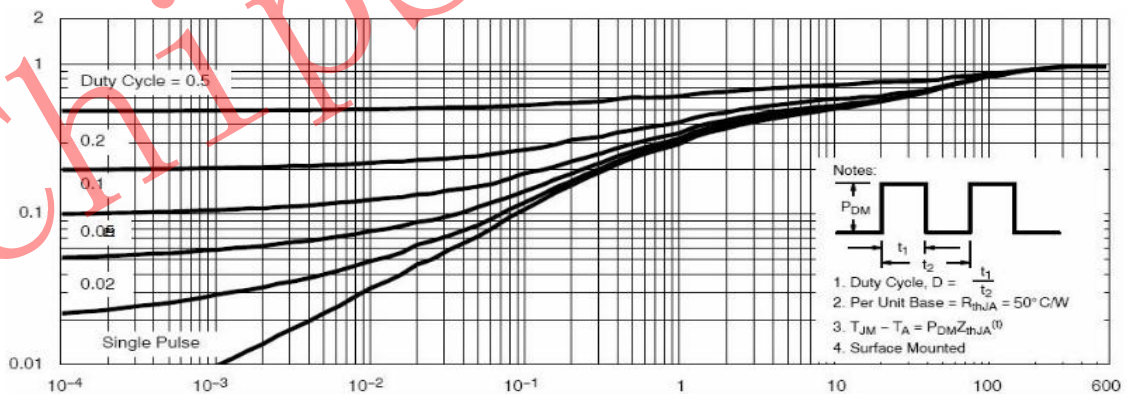

Square Wave Pulse Duration(sec)

Figure 11 Normalized Maximum Transient Thermal Impedance



SOP-8 Package Information

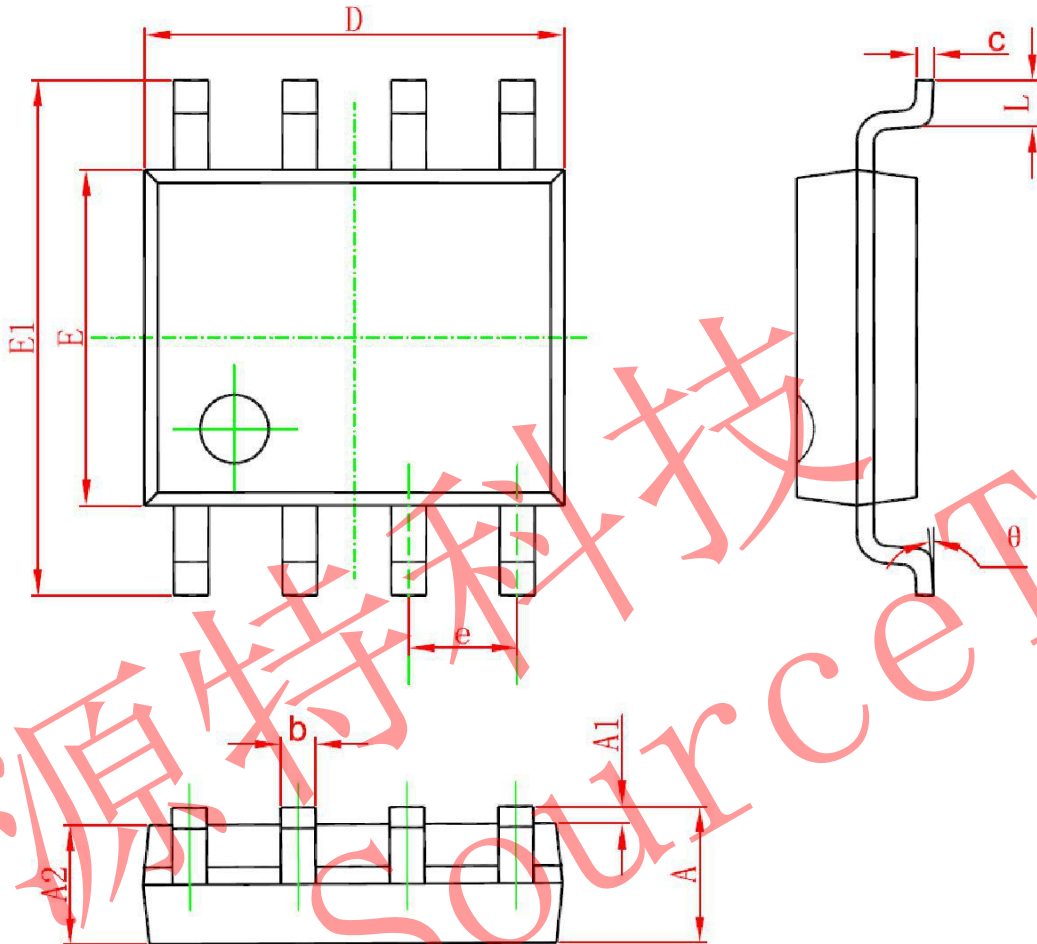

Symbol	Dimensions In Millimeters		Dimensions In Inches	
	Min	Max	Min	Max
A	1.350	1.750	0.053	0.069
A1	0.100	0.250	0.004	0.010
A2	1.350	1.550	0.053	0.061
b	0.330	0.510	0.013	0.020
c	0.170	0.250	0.006	0.010
D	4.700	5.100	0.185	0.200
E	3.800	4.000	0.150	0.157
E1	5.800	6.200	0.228	0.244
e	1.270 (BSC)		0.050 (BSC)	
L	0.400	1.270	0.016	0.050
θ	0°	8°	0°	8°