



P-Channel Enhancement Mode Power MOSFET

Description

The PE40P36K uses advanced trench technology to provide excellent $R_{DS(ON)}$ and low gate charge. It can be used in a wide variety of applications.

General Features

- $V_{DS} = -40V$, $I_D = -36A$

$R_{DS(ON)} < 21m\Omega$ @ $V_{GS} = -10V$

$R_{DS(ON)} < 32m\Omega$ @ $V_{GS} = -4.5V$

- High Power and current handling capability
- Lead free product is acquired
- Surface Mount Package

Application

- DC-DC converter
- Load switch
- Power management

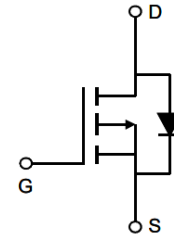

Schematic diagram

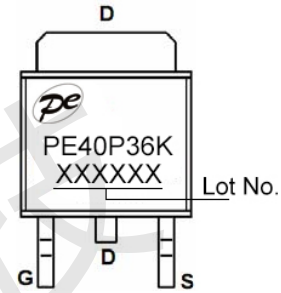

Marking and pin assignment

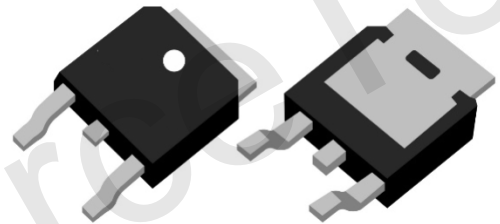

TO-252-2L

Absolute Maximum Ratings (TC=25°C unless otherwise noted)

Parameter	Symbol	Rating	Unit
Drain-Source Voltage	V_{DS}	-40	V
Gate-Source Voltage	V_{GS}	± 20	V
Drain Current-Continuous	I_D	-36	A
Drain Current-Continuous ($T_C=100^\circ C$)	$I_D(T_C=100^\circ C)$	-25	A
Pulsed Drain Current (Note 1)	I_{DM}	-114	A
Maximum Power Dissipation	P_D	60	W
Maximum Power Dissipation ($T_C=100^\circ C$)	$P_D(T_C=100^\circ C)$	30	W
Operating Junction and Storage Temperature Range	T_J, T_{STG}	-55 To 175	$^\circ C$

Thermal Characteristic

Thermal Resistance, Junction-to-Case (Note 2)	$R_{\theta JC}$	2.5	$^\circ C/W$
---	-----------------	-----	--------------



Electrical Characteristics (TC=25°C unless otherwise noted)

Parameter	Symbol	Condition	Min	Typ	Max	Unit
Off Characteristics						
Drain-Source Breakdown Voltage	BV_{DSS}	$V_{GS}=0V, I_D=-250\mu A$	-40	-	-	V
Zero Gate Voltage Drain Current	I_{DSS}	$V_{DS}=-40V, V_{GS}=0V$	-	-	-1	μA
Gate-Body Leakage Current	I_{GSS}	$V_{GS}=\pm 20V, V_{DS}=0V$	-	-	± 100	nA
On Characteristics (Note 3)						
Gate Threshold Voltage	$V_{GS(th)}$	$V_{DS}=V_{GS}, I_D=-250\mu A$	-1.1	-1.7	-2.5	V
Drain-Source On-State Resistance	$R_{DS(on)}$	$V_{GS}=-10V, I_D=-20A$	-	15	21	$m\Omega$
		$V_{GS}=-4.5V, I_D=-15A$	-	21	32	$m\Omega$
Forward Transconductance	g_{FS}	$V_{DS}=-5V, I_D=-5A$	15	-	-	S
Dynamic Characteristics (Note 4)						
Input Capacitance	C_{iss}	$V_{DS}=-20V, V_{GS}=0V,$ $F=1.0MHz$	-	2050	-	pF
Output Capacitance	C_{oss}		-	140	-	pF
Reverse Transfer Capacitance (Note 4)	C_{rss}		-	130	-	pF
Switching Characteristics						
Turn-on Delay Time	$t_{d(on)}$	$V_{DS}=-20V, R_L=1.6\Omega,$ $V_{GS}=-10V, R_G=3\Omega$	-	10	-	nS
Turn-on Rise Time	t_r		-	24	-	nS
Turn-Off Delay Time	$t_{d(off)}$		-	40	-	nS
Turn-Off Fall Time	t_f		-	9	-	nS
Total Gate Charge	Q_g	$V_{DS}=-20V, I_D=-8A,$ $V_{GS}=-10V$	-	45	-	nC
Gate-Source Charge	Q_{gs}		-	6	-	nC
Gate-Drain Charge	Q_{gd}		-	11	-	nC
Drain-Source Diode Characteristics						
Diode Forward Voltage (Note 3)	V_{SD}	$V_{GS}=0V, I_S=-10A$	-	-	-1.2	V
Diode Forward Current (Note 2)	I_S		-	-	-36	A

Notes:

1. Repetitive Rating: Pulse width limited by maximum junction temperature.
2. Surface Mounted on FR4 Board, $t \leq 10$ sec.
3. Pulse Test: Pulse Width $\leq 300\mu s$, Duty Cycle $\leq 2\%$.
4. Guaranteed by design, not subject to product.



Typical Electrical and Thermal Characteristics

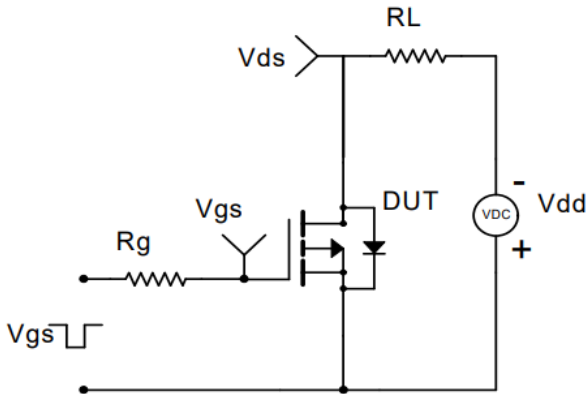

Figure 1 Switching Test Circuit

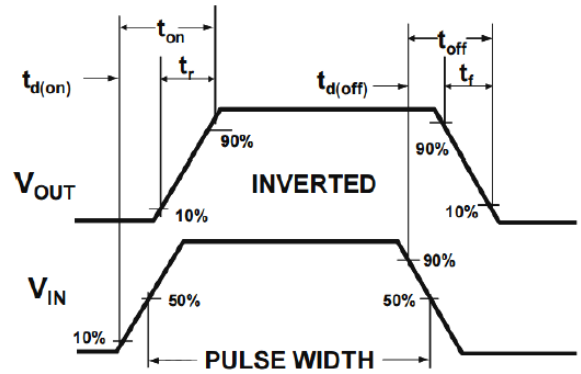
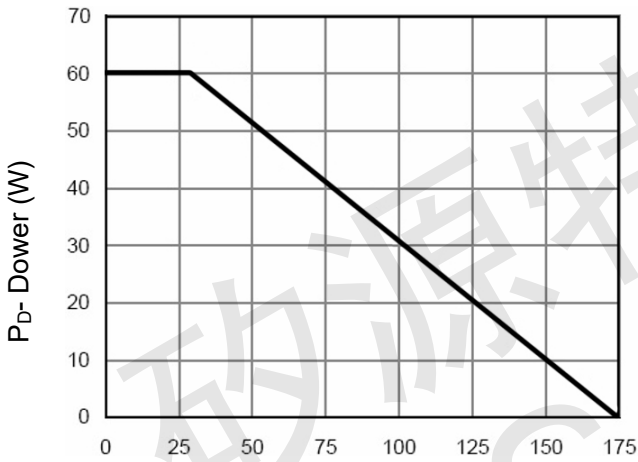
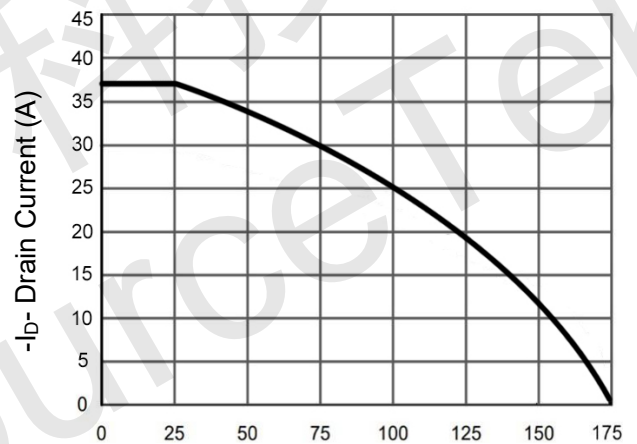

Figure 2 Switching Waveform



T_J-Junction Temperature (°C)

Figure 3 Power De-rating



T_J-Junction Temperature (°C)

Figure 4 Drain Current

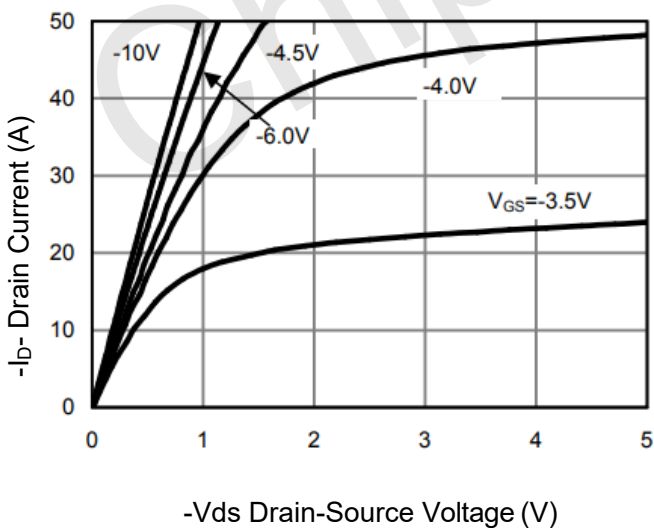

-V_{DS} Drain-Source Voltage (V)

Figure 5 Output Characteristics

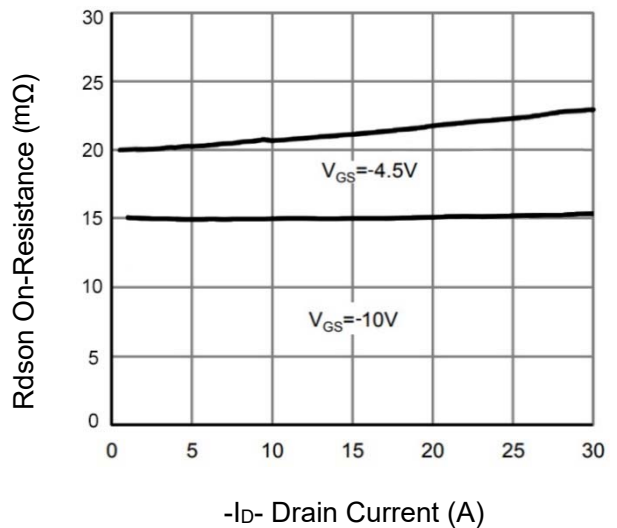

-I_D - Drain Current (A)

Figure 6 Rdson vs Drain Current

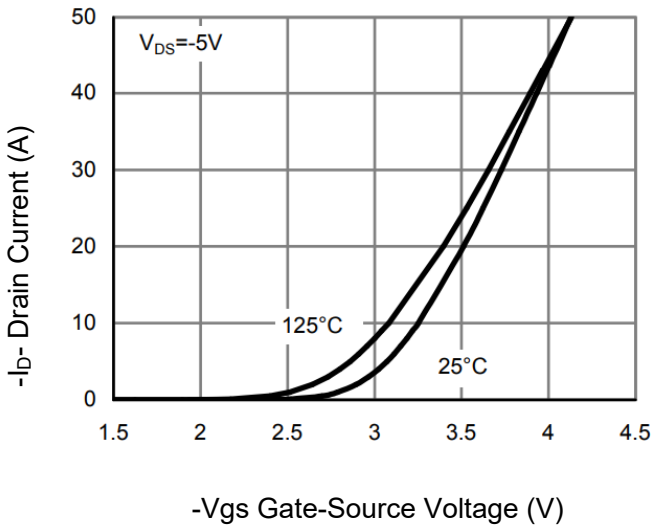

Figure 7 Transfer Characteristics

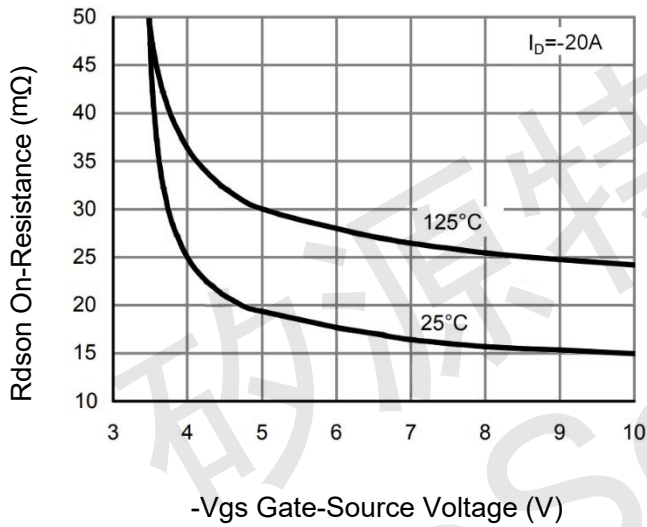

Figure 9 Rdson vs Vgs

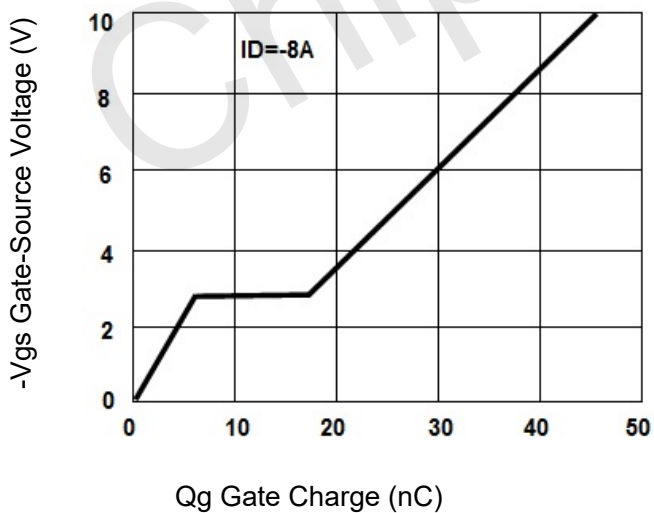

Figure 11 Gate Charge

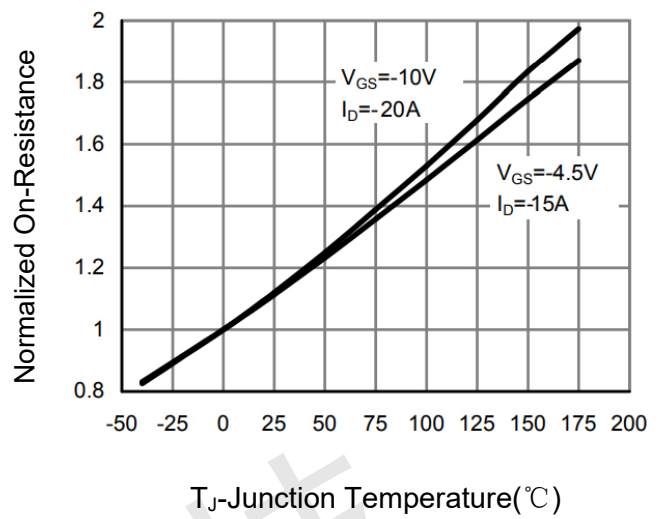

Figure 8 Rdson vs Junction Temperature

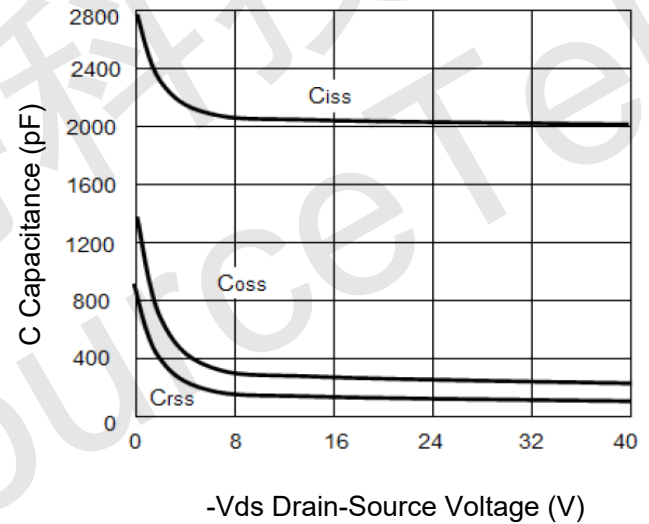

Figure 10 Capacitance vs Vds

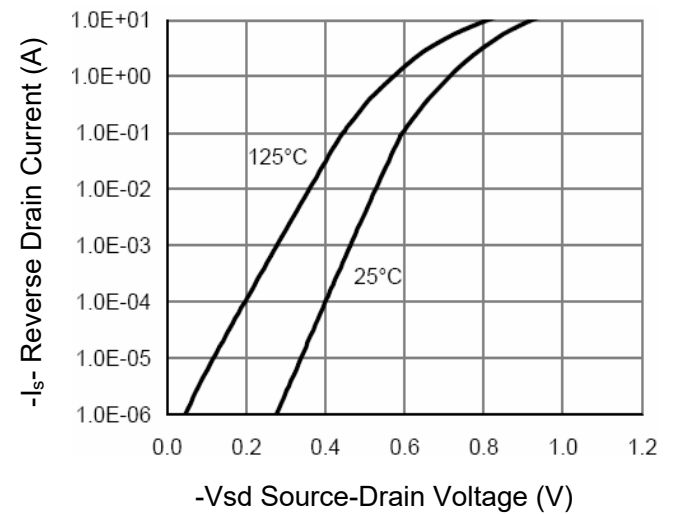

Figure 12 Source- Drain Diode Forward

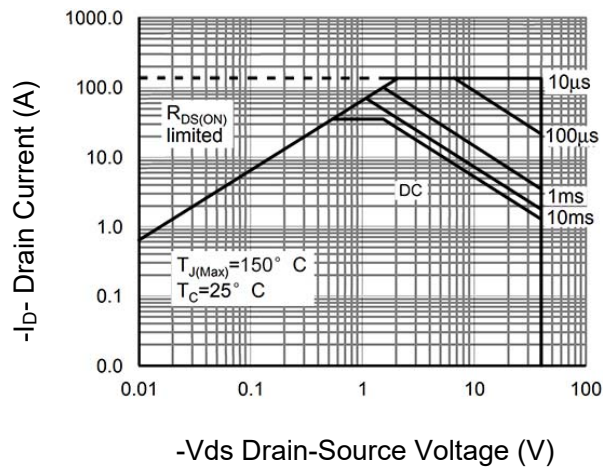

Figure 13 Safe Operation Area

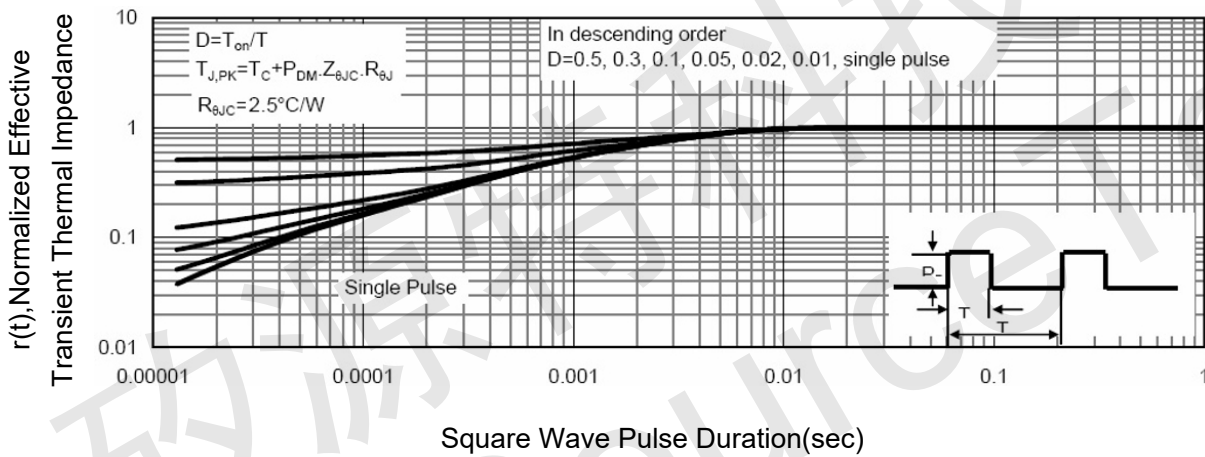
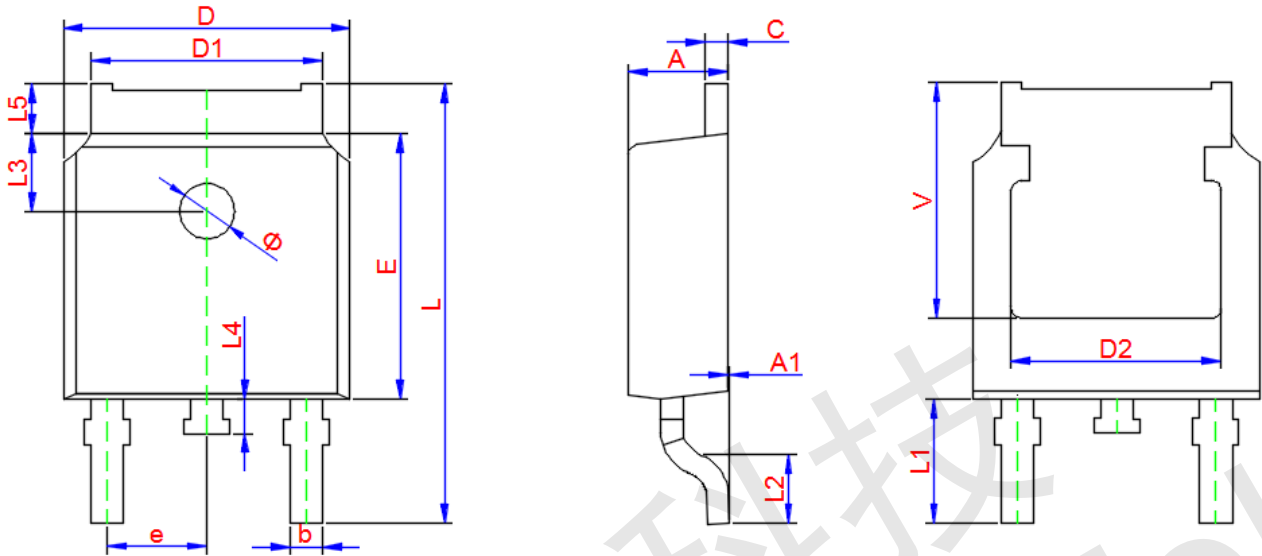

Figure 14 Normalized Maximum Transient Thermal Impedance



TO-252-2L Package Information



Symbol	Dimensions In Millimeters		
	Min.	Typ.	Max.
A	2.200	2.300	2.400
A1	0.000	--	0.127
D	6.500	6.600	6.700
D1	5.100	5.330	5.460
C	0.450	0.500	0.600
D2	4.830 TYP.		
E	6.000	6.100	6.200
e	2.186	2.286	2.386
L	9.800	10.100	10.400
L1	2.900 TYP.		
L2	1.400	1.500	1.600
L3	1.800 TYP.		
L4	0.600	0.800	1.000
L5	0.900	--	1.250
Φ	1.100.	--	1.300
θ	0°	--	8°
V	5.350		