



N and P Channel Enhancement Mode Power MOSFET

Description

The PE4606 uses advanced trench technology to provide excellent $R_{DS(ON)}$ and low gate charge. It can be used in a wide variety of applications.

General Features

- **N-Channel**
 - $V_{DS} = 30V$, $I_D = 6.5A$
 - $R_{DS(ON)} < 30m\Omega @ V_{GS}=10V$
 - $R_{DS(ON)} < 42m\Omega @ V_{GS}=4.5V$
- **P-Channel**
 - $V_{DS} = -30V$, $I_D = -6A$
 - $R_{DS(ON)} < 33m\Omega @ V_{GS}=-10V$
 - $R_{DS(ON)} < 44m\Omega @ V_{GS}=-4.5V$
- High Power and current handing capability
- Lead free product is acquired
- Surface Mount Package

Application

- PWM applications
- DC motor

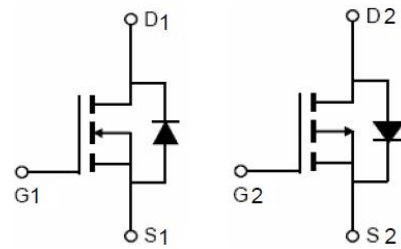

Schematic diagram

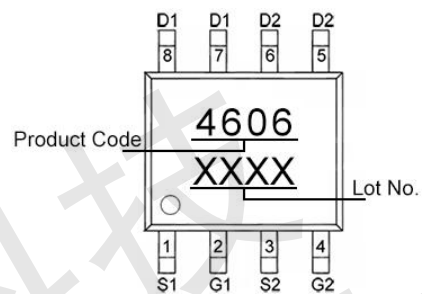

Marking and pin assignment

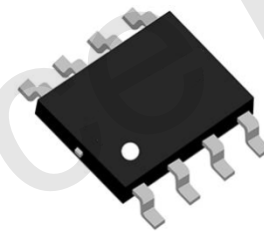

SOP-8

Absolute Maximum Ratings (TA=25°C unless otherwise noted)

Parameter	Symbol	N-Channel	P-Channel	Unit
Drain-Source Voltage	V_{DS}	30	-30	V
Gate-Source Voltage	V_{GS}	± 20	± 20	V
Drain Current-Continuous	I_D	6.5	-6	A
Pulsed Drain Current (Note 1)	I_{DM}	30	-30	A
Maximum Power Dissipation	P_D	2	2	W
Operating Junction and Storage Temperature Range	T_J, T_{STG}	-55 To 150		°C

Thermal Characteristic

Parameter	Symbol	N-Channel	P-Channel	Unit
Thermal Resistance, Junction-to-Ambient (Note 2)	$R_{\theta JA}$	62.5	62.5	°C/W



N-Channel Electrical Characteristics (TA=25°C unless otherwise noted)

Parameter	Symbol	Condition	Min	Typ	Max	Unit
Off Characteristics						
Drain-Source Breakdown Voltage	BV_{DSS}	$V_{GS}=0V, I_D=250\mu A$	30	-	-	V
Zero Gate Voltage Drain Current	I_{DSS}	$V_{DS}=30V, V_{GS}=0V$	-	-	1	μA
Gate-Body Leakage Current	I_{GSS}	$V_{GS}=\pm 20V, V_{DS}=0V$	-	-	± 100	nA
On Characteristics (Note 3)						
Gate Threshold Voltage	$V_{GS(th)}$	$V_{DS}=V_{GS}, I_D=250\mu A$	1	1.6	2.4	V
Drain-Source On-State Resistance	$R_{DS(on)}$	$V_{GS}=10V, I_D=6A$	-	20	30	m Ω
		$V_{GS}=4.5V, I_D=5A$	-	25	42	m Ω
Forward Transconductance	g_{FS}	$V_{DS}=10V, I_D=5A$	-	15	-	S
Dynamic Characteristics (Note 4)						
Input Capacitance	C_{iss}	$V_{DS}=15V, V_{GS}=0V,$ $F=1.0MHz$	-	560	-	pF
Output Capacitance	C_{oss}		-	75	-	pF
Reverse Transfer Capacitance (Note 4)	C_{rss}		-	60	-	pF
Switching Characteristics						
Turn-on Delay Time	$t_{d(on)}$	$V_{DS}=15V, I_D=2A, R_L=1\Omega,$ $V_{GS}=10V, R_G=3\Omega$	-	4.5	-	nS
Turn-on Rise Time	t_r		-	2.5	-	nS
Turn-Off Delay Time	$t_{d(off)}$		-	14.5	-	nS
Turn-Off Fall Time	t_f		-	3.5	-	nS
Total Gate Charge	Q_g	$V_{DS}=15V, I_D=5A, V_{GS}=10V$	-	11	-	nC
Gate-Source Charge	Q_{gs}		-	1.65	-	nC
Gate-Drain Charge	Q_{gd}		-	2.7	-	nC
Drain-Source Diode Characteristics						
Diode Forward Voltage (Note 3)	V_{SD}	$V_{GS}=0V, I_S=1A$	-	-	1.2	V
Diode Forward Current (Note 2)	I_S		-	-	2.5	A

Notes:

1. Repetitive Rating: Pulse width limited by maximum junction temperature.
2. Surface Mounted on FR4 Board, $t \leq 10$ sec.
3. Pulse Test: Pulse Width $\leq 300\mu s$, Duty Cycle $\leq 2\%$.
4. Guaranteed by design, not subject to product.



Typical Electrical and Thermal Characteristics

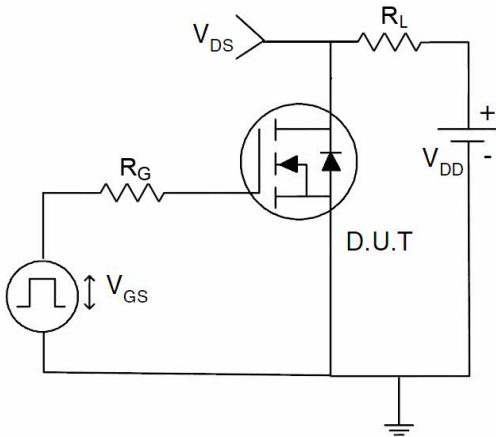

Figure 1 Switching Test Circuit

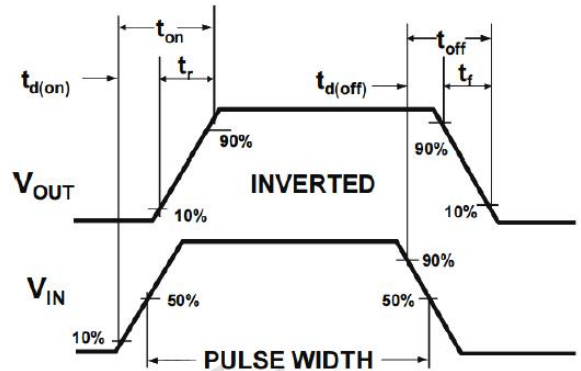
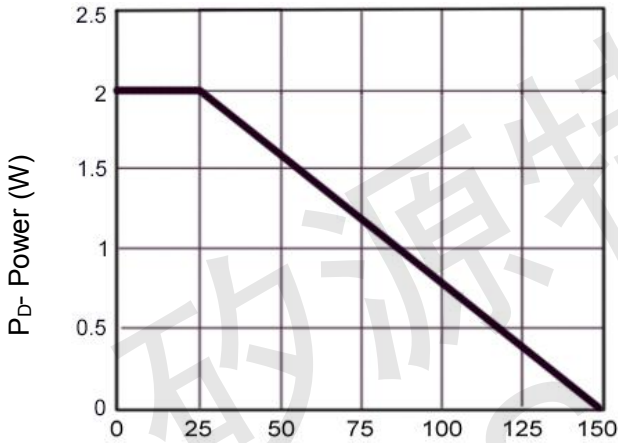
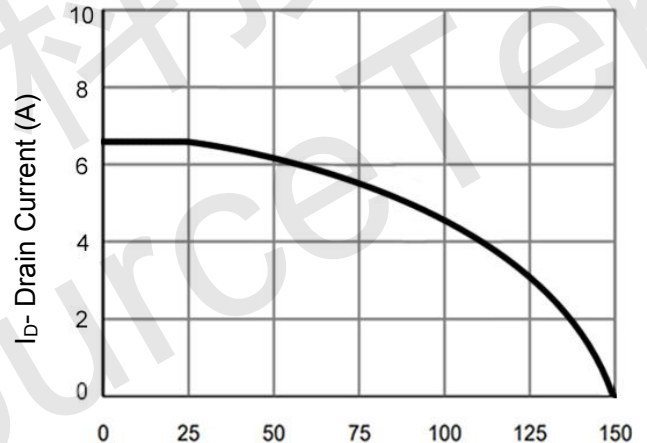

Figure 2 Switching Waveform



T_J -Junction Temperature ($^{\circ}C$)

Figure 3 Power De-rating



T_J -Junction Temperature ($^{\circ}C$)

Figure 4 Drain Current

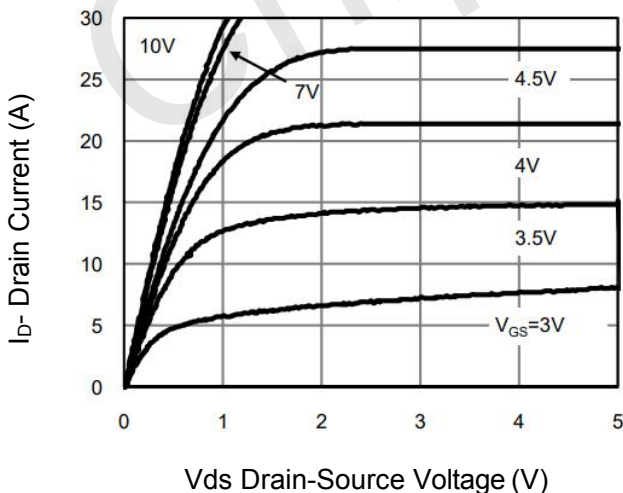

Figure 5 Output Characteristics

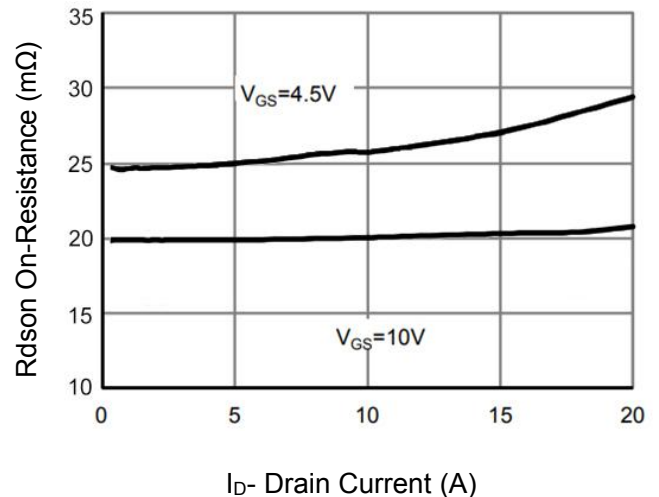

Figure 6 R_{dson} vs Drain Current

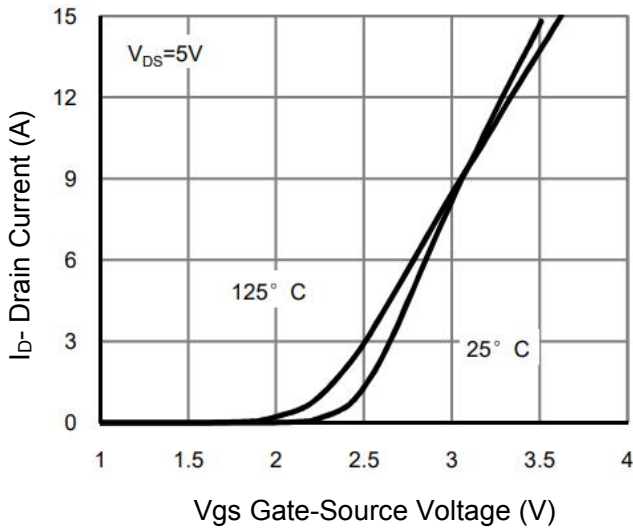

Figure 7 Transfer Characteristics

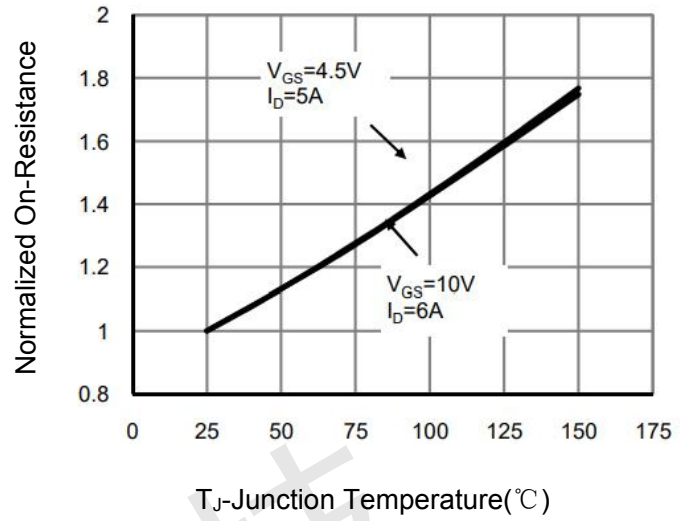

Figure 8 Rdson vs Junction Temperature

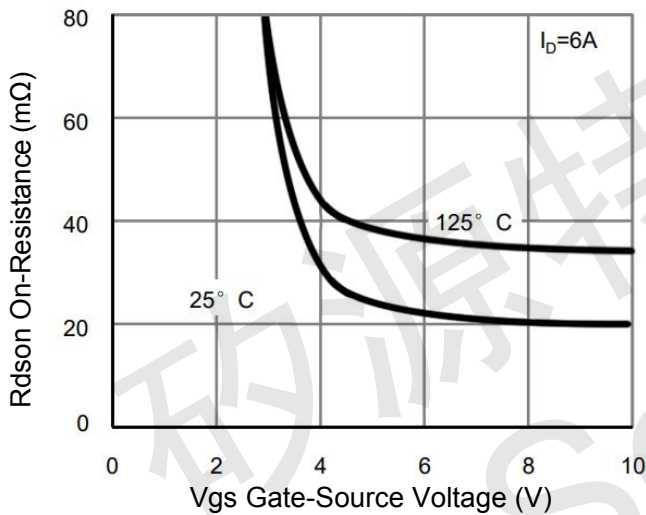

Figure 9 Rdson vs Vgs

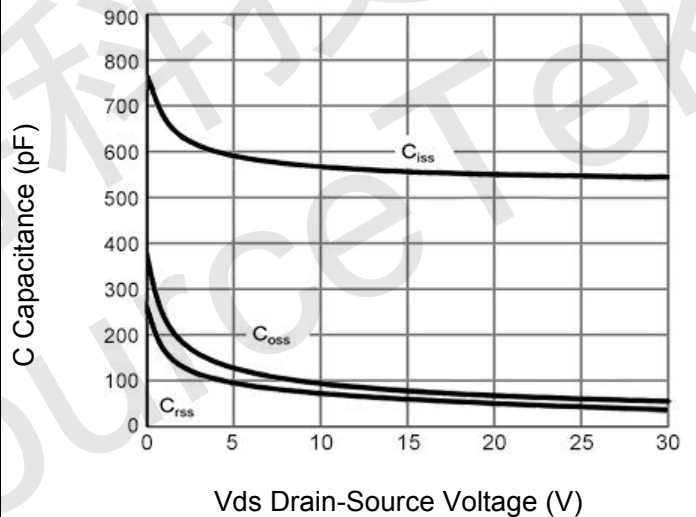

Figure 10 Capacitance vs Vds

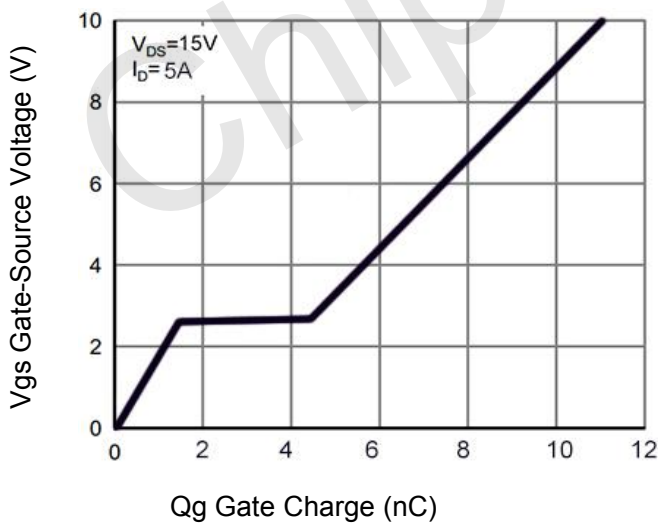

Figure 11 Gate Charge

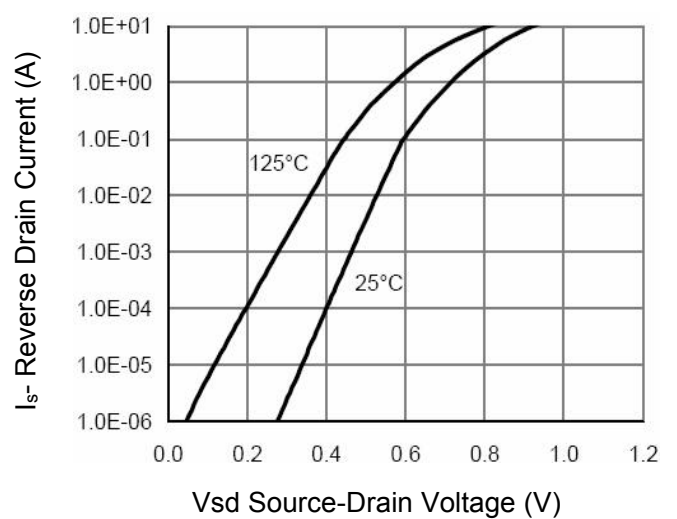

Figure 12 Source- Drain Diode Forward

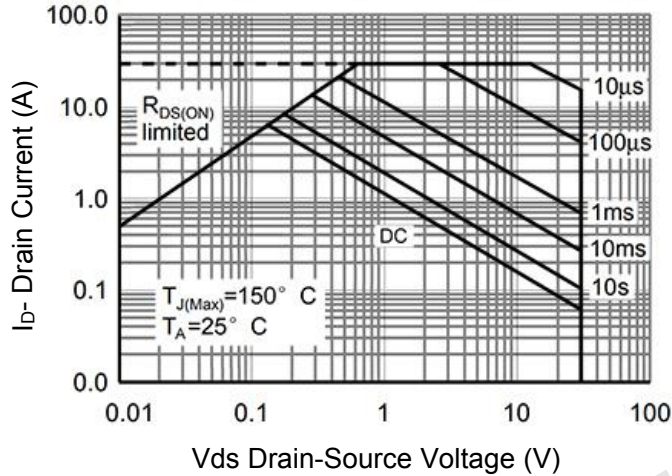

Figure 13 Safe Operation Area

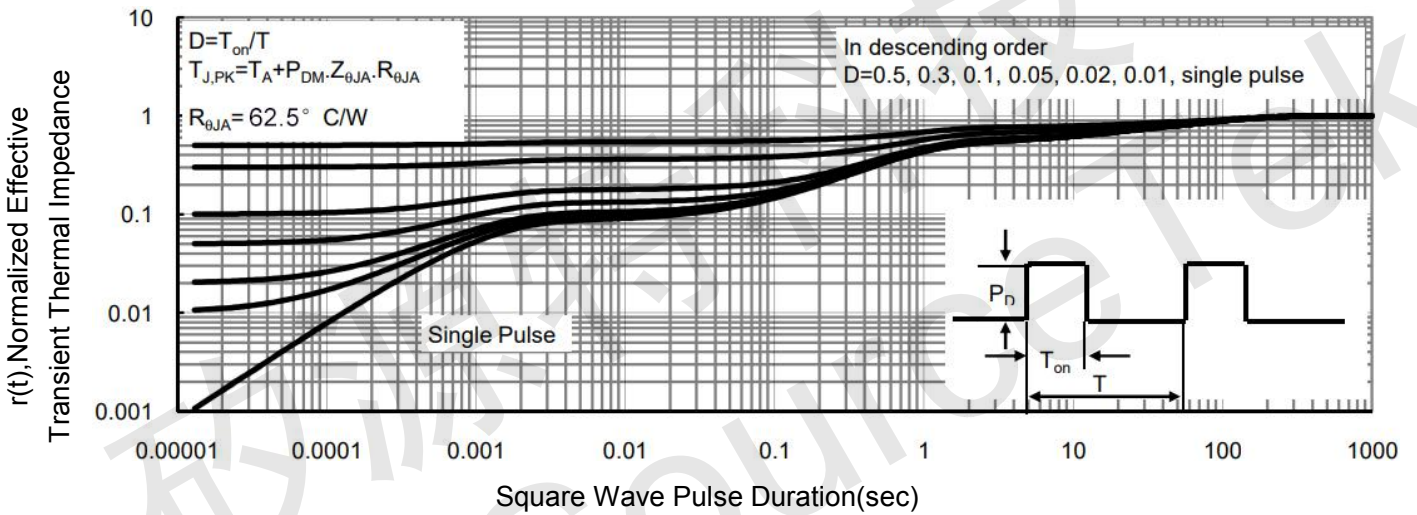

Figure 14 Normalized Maximum Transient Thermal Impedance



P-Channel Electrical Characteristics (TA=25°C unless otherwise noted)

Parameter	Symbol	Condition	Min	Typ	Max	Unit
Off Characteristics						
Drain-Source Breakdown Voltage	BV_{DSS}	$V_{GS}=0V, I_D=-250\mu A$	-30	-	-	V
Zero Gate Voltage Drain Current	I_{DSS}	$V_{DS}=-30V, V_{GS}=0V$	-	-	1	μA
Gate-Body Leakage Current	I_{GSS}	$V_{GS}=\pm 20V, V_{DS}=0V$	-	-	± 100	nA
On Characteristics (Note 3)						
Gate Threshold Voltage	$V_{GS(th)}$	$V_{DS}=V_{GS}, I_D=-250\mu A$	-1.0	-1.5	-2.4	V
Drain-Source On-State Resistance	$R_{DS(ON)}$	$V_{GS}=-10V, I_D=-6A$	-	25	33	m Ω
		$V_{GS}=-4.5V, I_D=-4A$	-	35	44	m Ω
Forward Transconductance	g_{FS}	$V_{DS}=-10V, I_D=-6A$	-	15	-	S
Dynamic Characteristics (Note 4)						
Input Capacitance	C_{iss}	$V_{DS}=-15V, V_{GS}=0V,$ $F=1.0MHz$	-	480	-	pF
Output Capacitance	C_{oss}		-	120	-	pF
Reverse Transfer Capacitance (Note 4)	C_{rss}		-	54	-	pF
Switching Characteristics						
Turn-on Delay Time	$t_{d(on)}$	$V_{DD}=-15V, I_D=-2A, R_L=1\Omega,$ $V_{GS}=-10V, R_G=3\Omega$	-	8	-	nS
Turn-on Rise Time	t_r		-	5	-	nS
Turn-Off Delay Time	$t_{d(off)}$		-	28	-	nS
Turn-Off Fall Time	t_f		-	12	-	nS
Total Gate Charge	Q_g		-	14	-	nC
Gate-Source Charge	Q_{gs}		$V_{DS}=-15V, I_D=-4A, V_{GS}=-10V$	-	2	-
Gate-Drain Charge	Q_{gd}		-	3	-	nC
Drain-Source Diode Characteristics						
Diode Forward Voltage (Note 3)	V_{SD}	$V_{GS}=0V, I_S=-1A$	-	-	-1.2	V
Diode Forward Current (Note 2)	I_S		-	-	-2.5	A

Notes:

1. Repetitive Rating: Pulse width limited by maximum junction temperature.
2. Surface Mounted on FR4 Board, $t \leq 10$ sec.
3. Pulse Test: Pulse Width $\leq 300\mu s$, Duty Cycle $\leq 2\%$.
4. Guaranteed by design, not subject to product.



Typical Electrical and Thermal Characteristics

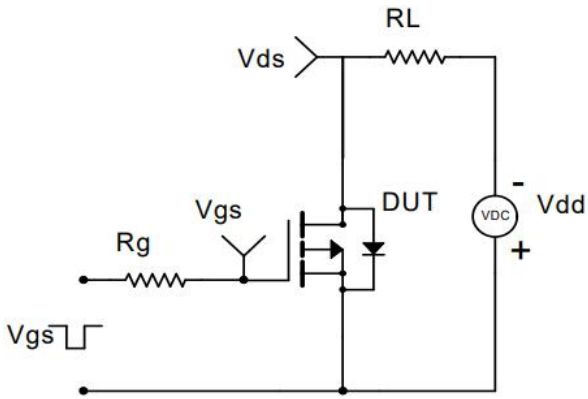

Figure 1 Switching Test Circuit

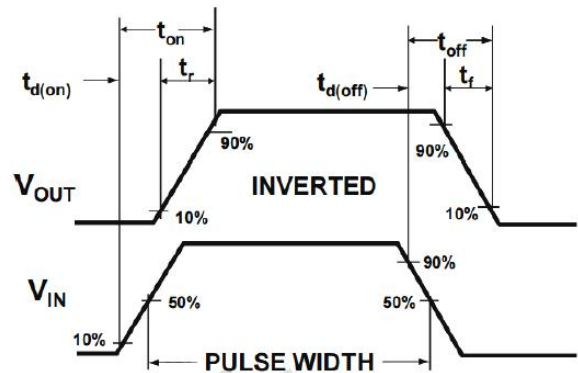

Figure 2 Switching Waveform

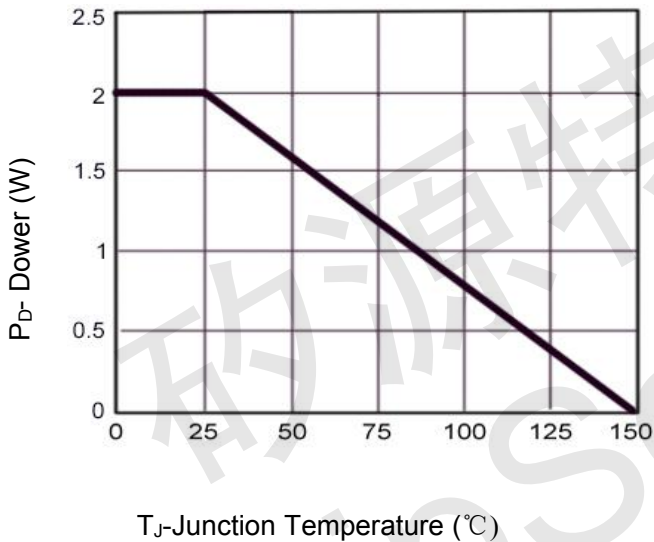

Figure 3 Power De-rating

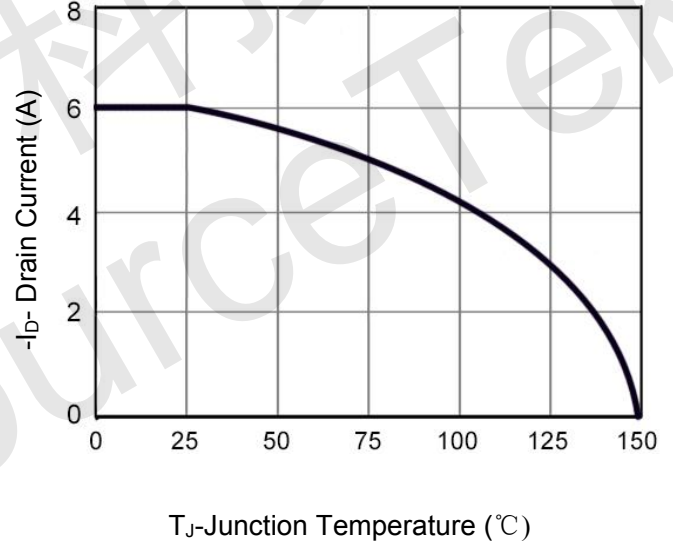

Figure 4 Drain Current

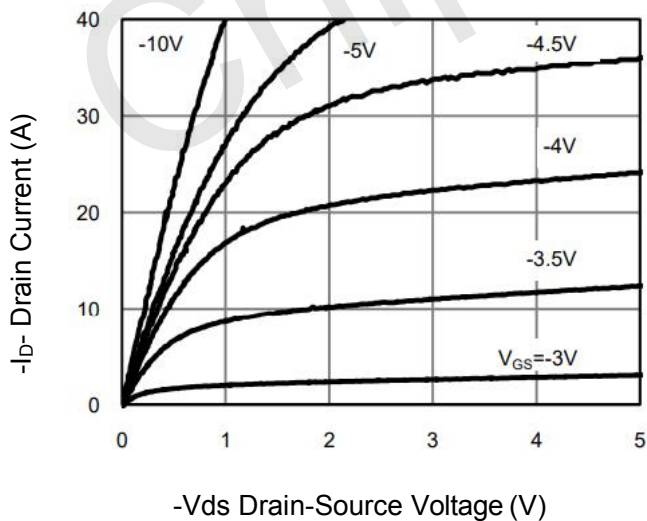

Figure 5 Output Characteristics

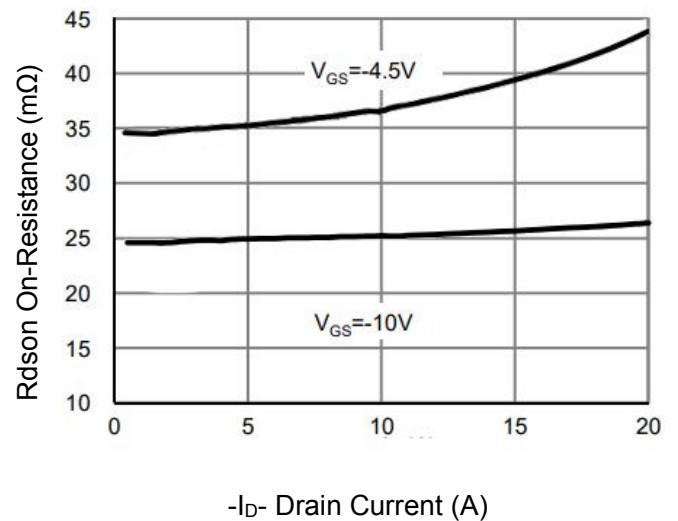

Figure 6 Rdson vs Drain Current

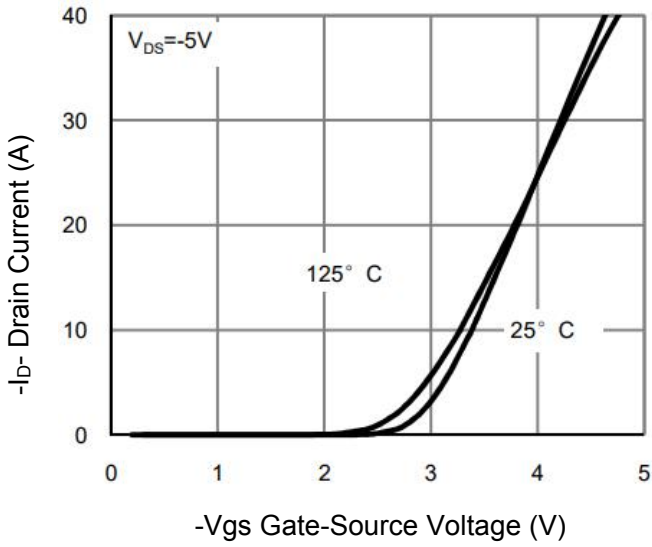

Figure 7 Transfer Characteristics

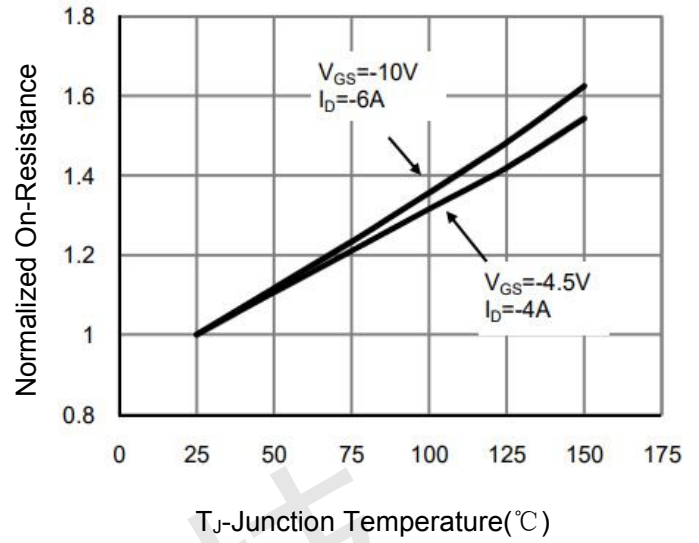

Figure 8 Rdson vs Junction Temperature

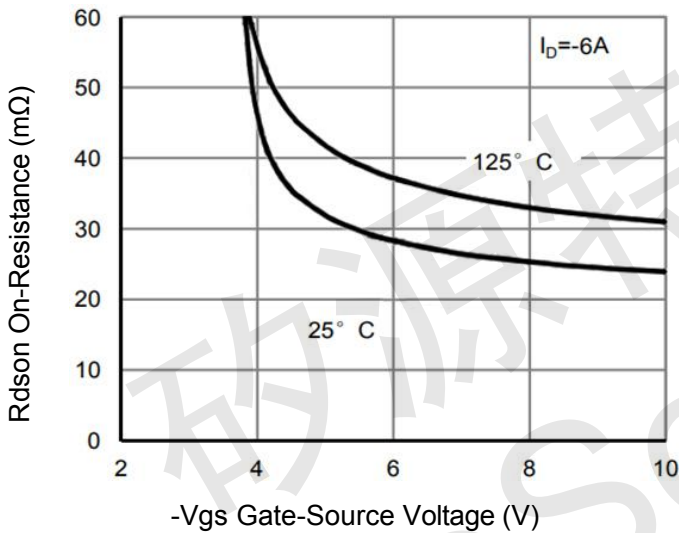

Figure 9 Rdson vs Vgs

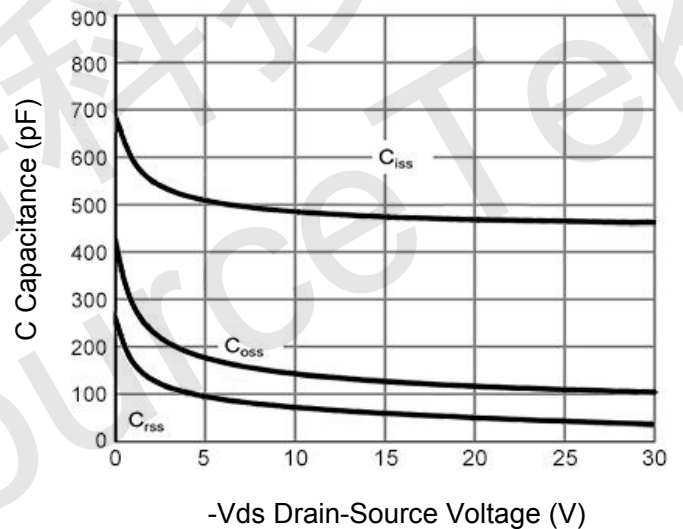

Figure 10 Capacitance vs Vds

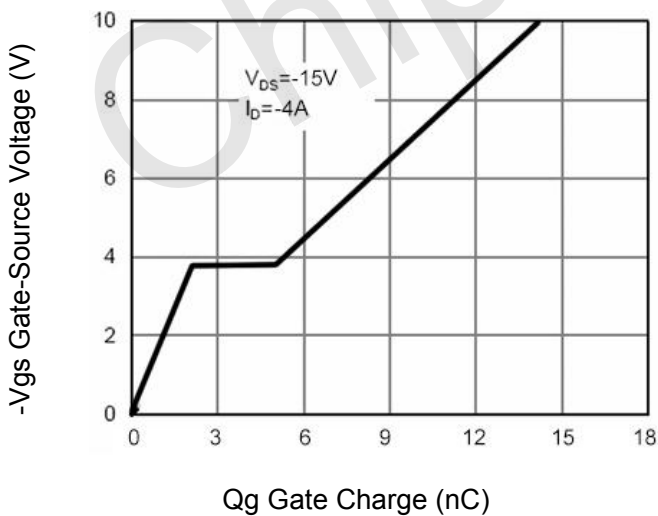

Figure 11 Gate Charge

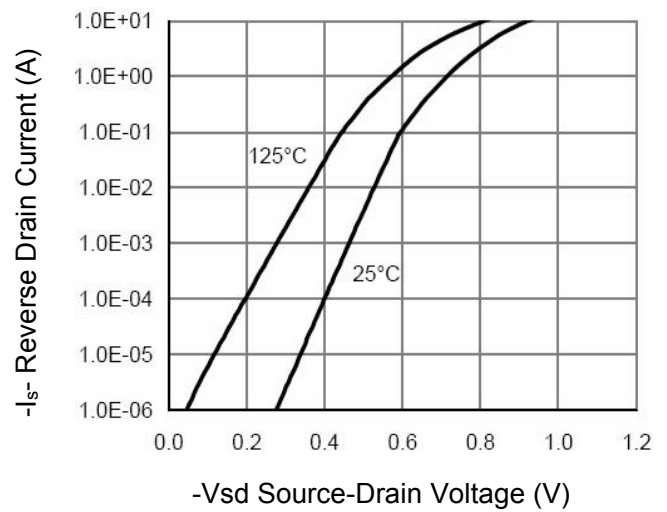

Figure 12 Source-Drain Diode Forward

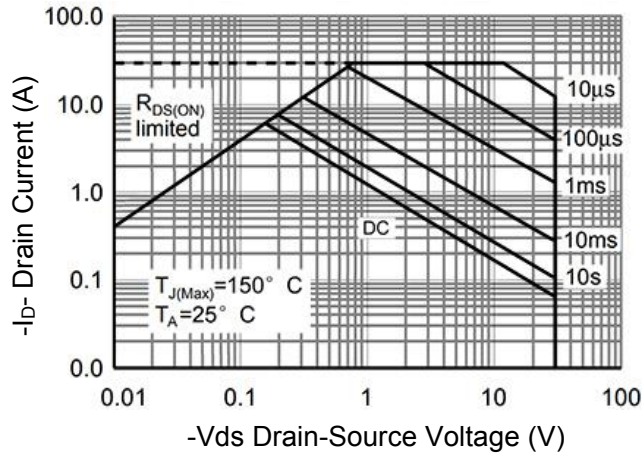

Figure 13 Safe Operation Area

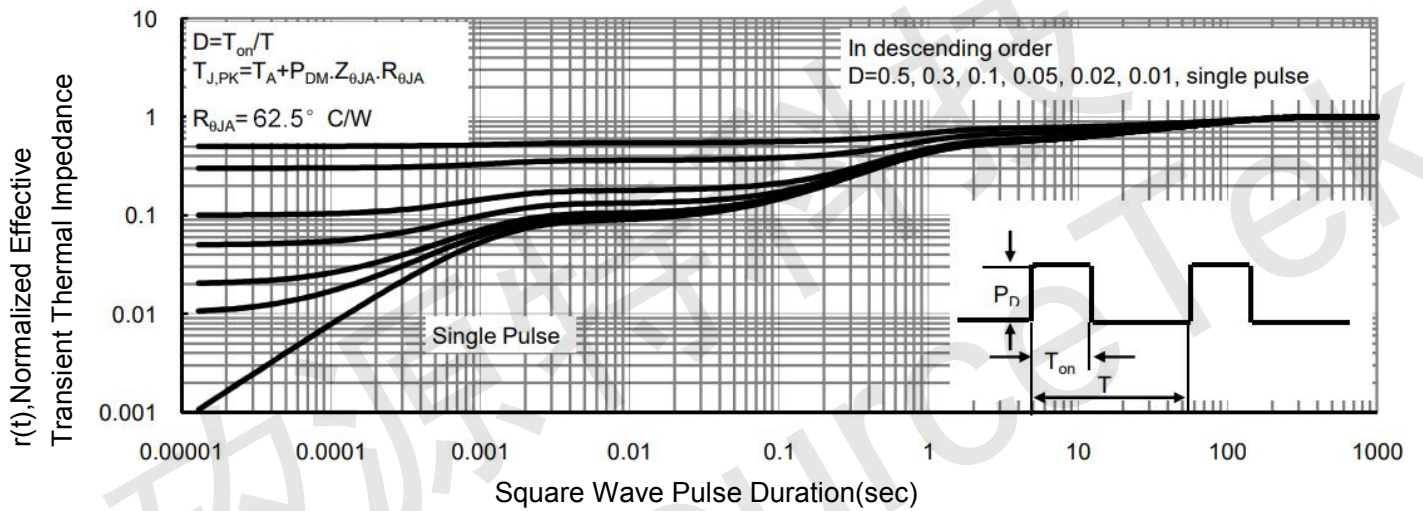
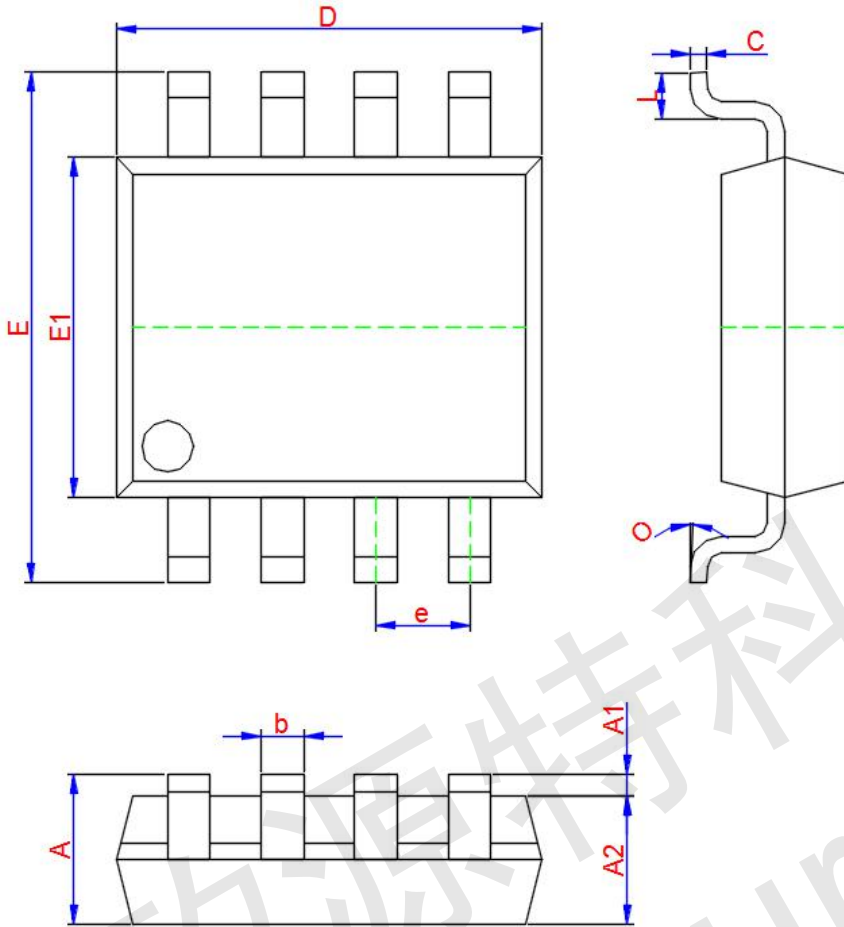

Figure 14 Normalized Maximum Transient Thermal Impedance



SOP-8 Package Information



Symbol	Dimensions In Millimeters		
	Min.	Typ.	Max.
A	1.350	1.550	1.750
A1	0.100	0.175	0.250
A2	1.350	1.450	1.550
b	0.330	0.420	0.510
c	0.170	0.210	0.250
D	4.700	4.900	5.100
e	1.270 TYP.		
E	5.800	6.000	6.200
E1	3.750	3.900	4.050
L	0.400	0.835	1.270
O	0°	4°	8°