



## N-Channel Enhancement Mode Power MOSFET

### Description

The PE8107Z0 uses advanced trench technology to provide excellent  $R_{DS(ON)}$  and low gate charge. It can be used in a wide variety of applications. It is ESD protected.

### General Features

- $V_{DS} = 18V$ ,  $I_D = 7A$

$R_{DS(ON)} < 15m\Omega @ V_{GS}=4.5V$

$R_{DS(ON)} < 17m\Omega @ V_{GS}=4V$

$R_{DS(ON)} < 18m\Omega @ V_{GS}=3.1V$

$R_{DS(ON)} < 20m\Omega @ V_{GS}=2.5V$

ESD Rating: 4000V HBM

- High Power and current handing capability
- Lead free product is acquired
- Surface Mount Package

### Application

- PWM applications
- Load switch
- Power management

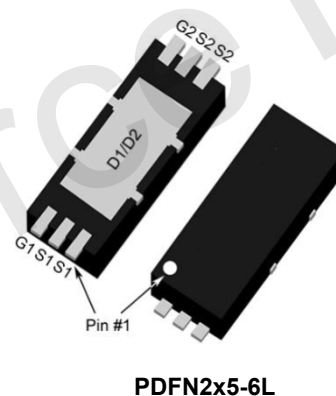
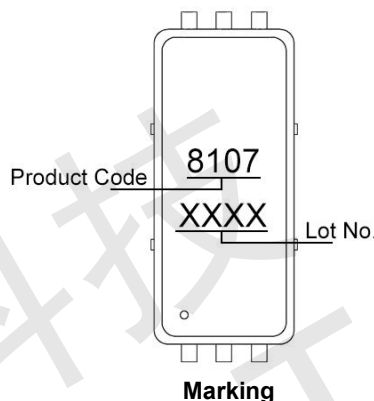
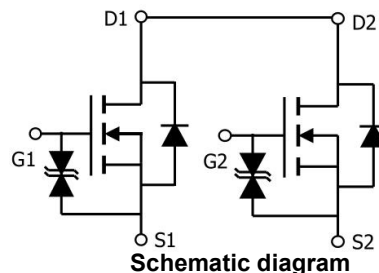

### Absolute Maximum Ratings (TA=25°C unless otherwise noted)

Parameter	Symbol	Rating	Unit
Drain-Source Voltage	$V_{DS}$	18	V
Gate-Source Voltage	$V_{GS}$	$\pm 12$	V
Drain Current-Continuous	$I_D$	7	A
Pulsed Drain Current (Note 1)	$I_{DM}$	70	A
Maximum Power Dissipation	$P_D$	1	W
Operating Junction and Storage Temperature Range	$T_J, T_{STG}$	-55 To 150	°C

### Thermal Characteristic

Thermal Resistance, Junction-to-Ambient (Note 2)	$R_{\theta JA}$	125	°C/W
--	-----------------	-----	------



**Electrical Characteristics (TA=25°C unless otherwise noted)**

Parameter	Symbol	Condition	Min	Typ	Max	Unit
<b>Off Characteristics</b>						
Drain-Source Breakdown Voltage	$BV_{DSS}$	$V_{GS}=0V, I_D=250\mu A$	-	18	-	V
Zero Gate Voltage Drain Current	$I_{DSS}$	$V_{DS}=16V, V_{GS}=0V$	-	-	1	$\mu A$
Gate-Body Leakage Current	$I_{GSS}$	$V_{GS}=\pm 10V, V_{DS}=0V$	-	-	$\pm 10$	$\mu A$
<b>On Characteristics (Note 3)</b>						
Gate Threshold Voltage	$V_{GS(th)}$	$V_{DS}=V_{GS}, I_D=250\mu A$	0.45	0.7	1.0	V
Drain-Source On-State Resistance	$R_{DS(on)}$	$V_{GS}=4.5V, I_D=6.5A$	-	11	15	m $\Omega$
		$V_{GS}=4V, I_D=5.6A$	-	12	17	m $\Omega$
		$V_{GS}=3.1V, I_D=5.6A$	-	13	18	m $\Omega$
		$V_{GS}=2.5V, I_D=5.6A$	-	14	20	m $\Omega$
Forward Transconductance	$g_{FS}$	$V_{DS}=5V, I_D=7A$	-	20	-	S
<b>Dynamic Characteristics (Note 4)</b>						
Input Capacitance	$C_{iss}$	$V_{DS}=10V, V_{GS}=0V,$ $F=1.0MHz$	-	760	-	pF
Output Capacitance	$C_{oss}$		-	205	-	pF
Reverse Transfer Capacitance (Note 4)	$C_{rss}$		-	190	-	pF
<b>Switching Characteristics</b>						
Turn-on Delay Time	$t_{d(on)}$	$V_{DD}=10V, I_D=2A, R_L=1\Omega,$ $V_{GS}=4.5V, R_G=3\Omega$	-	6	-	nS
Turn-on Rise Time	$t_r$		-	13	-	nS
Turn-Off Delay Time	$t_{d(off)}$		-	52	-	nS
Turn-Off Fall Time	$t_f$		-	16	-	nS
Total Gate Charge	$Q_g$	$V_{DS}=10V, I_D=5A,$ $V_{GS}=4.5V$	-	15	-	nC
Gate-Source Charge	$Q_{gs}$		-	1	-	nC
Gate-Drain Charge	$Q_{gd}$		-	3.2	-	nC
<b>Drain-Source Diode Characteristics</b>						
Diode Forward Voltage (Note 3)	$V_{SD}$	$V_{GS}=0V, I_S=1A$	-	-	1.2	V

**Notes:**

1. Repetitive Rating: Pulse width limited by maximum junction temperature.
2. Surface Mounted on FR4 Board,  $t \leq 10$  sec.
3. Pulse Test: Pulse Width  $\leq 300\mu s$ , Duty Cycle  $\leq 2\%$ .
4. Guaranteed by design, not subject to product.



### Typical Electrical and Thermal Characteristics



Figure 1 Switching Test Circuit



Figure 2 Switching Waveform

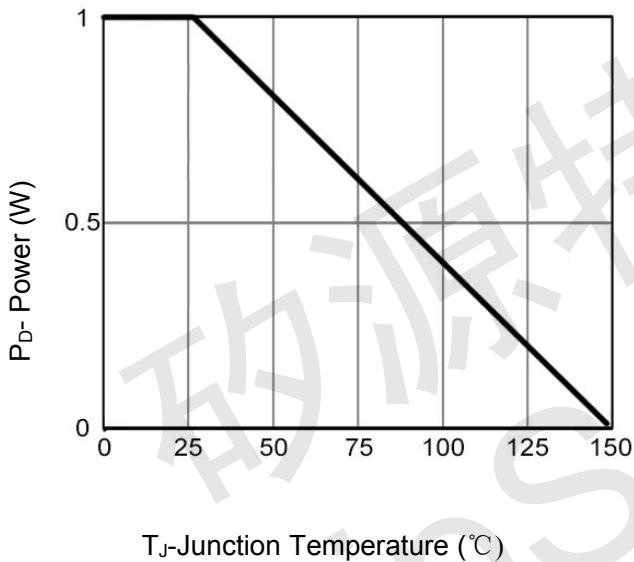

Figure 3 Power Dissipation

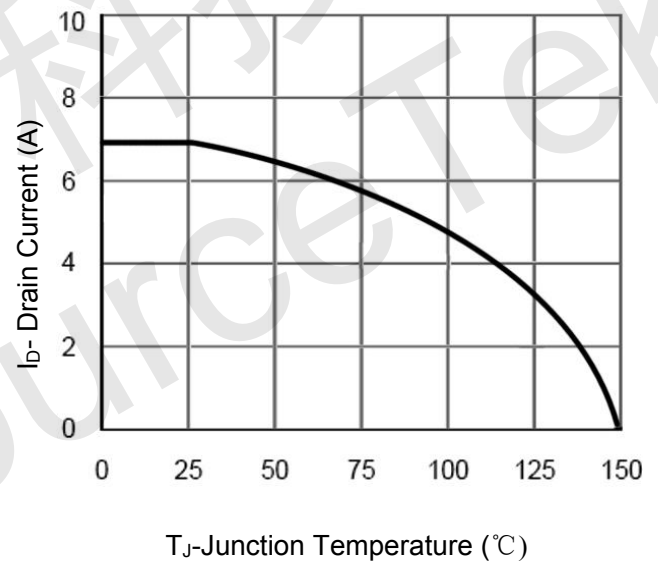

Figure 4 Drain Current

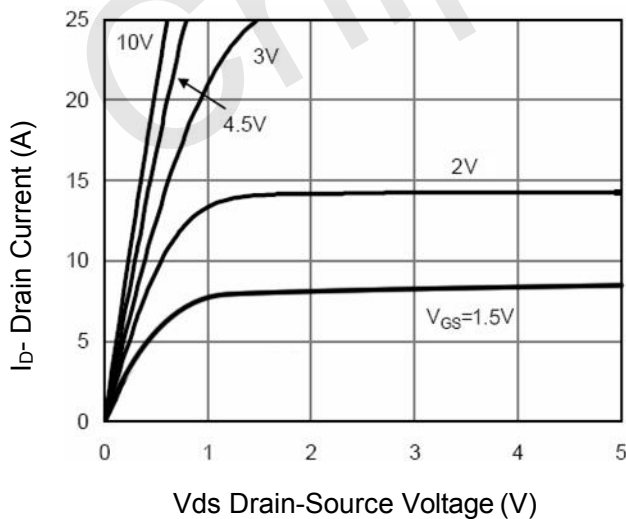

Figure 5 Output Characteristics

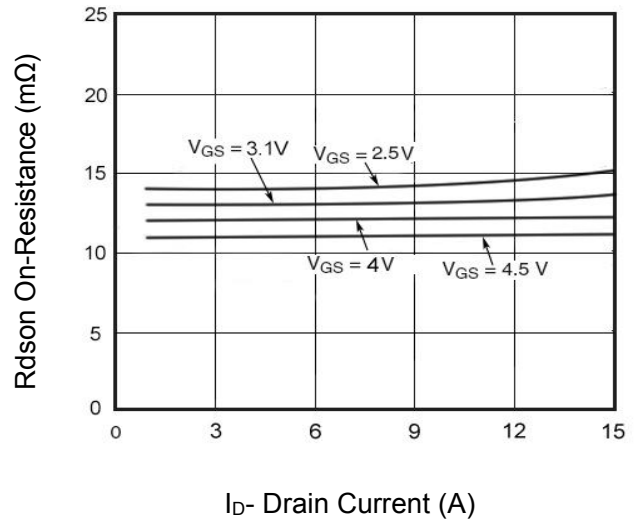

Figure 6 Rdson vs Drain Current

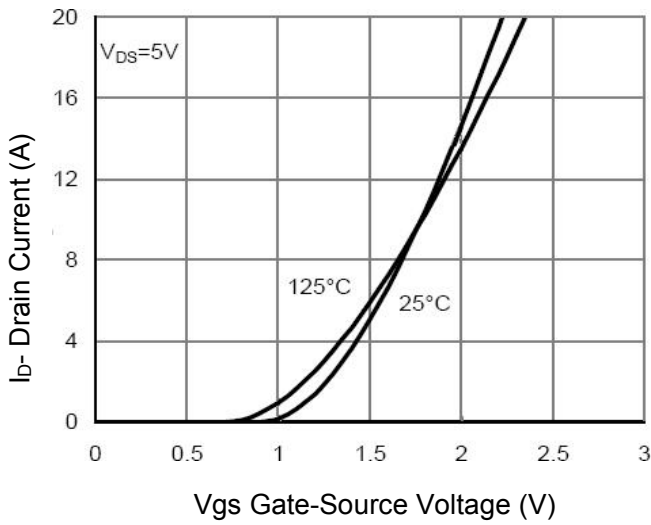

Figure 7 Transfer Characteristics

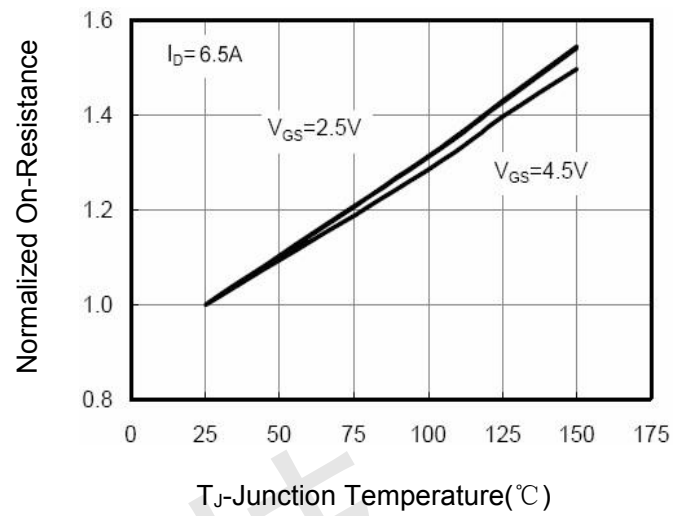

Figure 8  $R_{dson}$  vs Junction Temperature

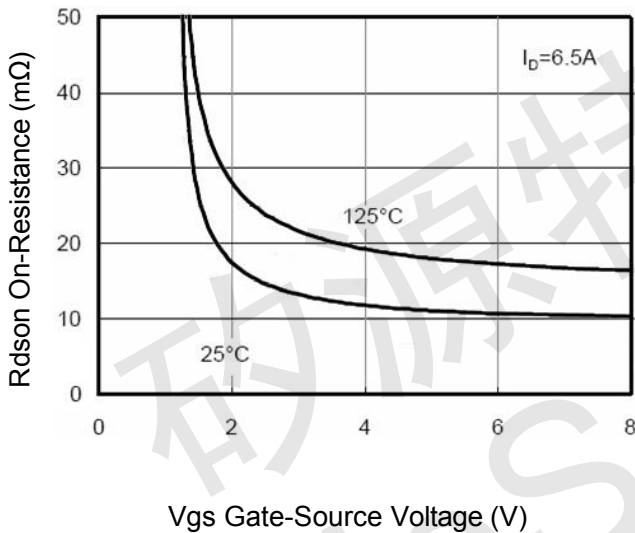

Figure 9  $R_{dson}$  vs  $V_{GS}$

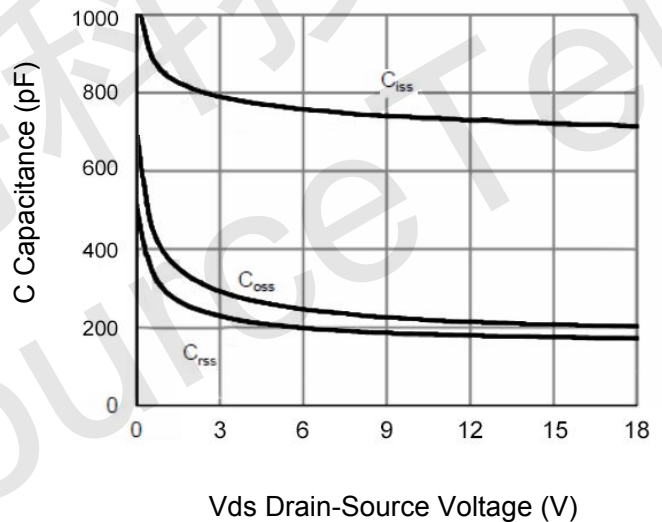

Figure 10 Capacitance vs  $V_{ds}$

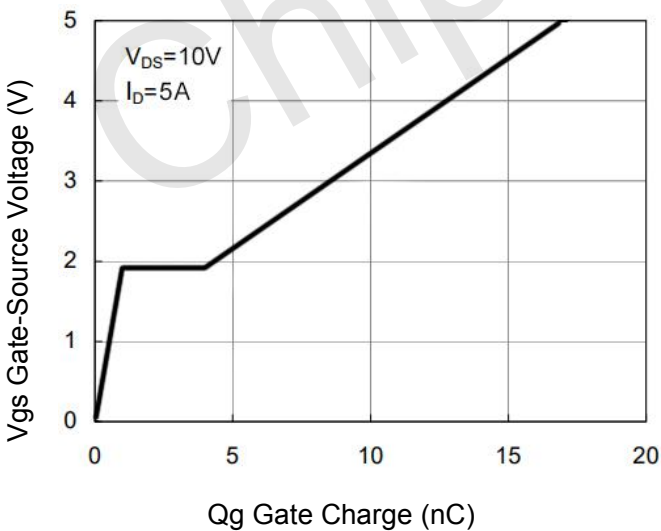

Figure 11 Gate Charge

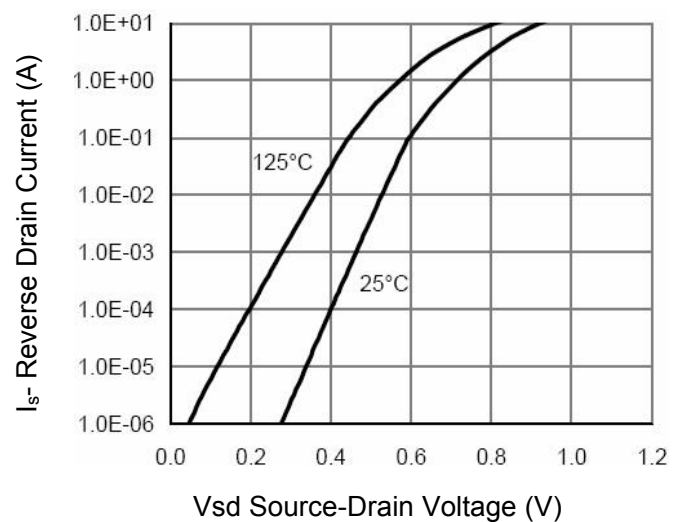

Figure 12 Source- Drain Diode Forward

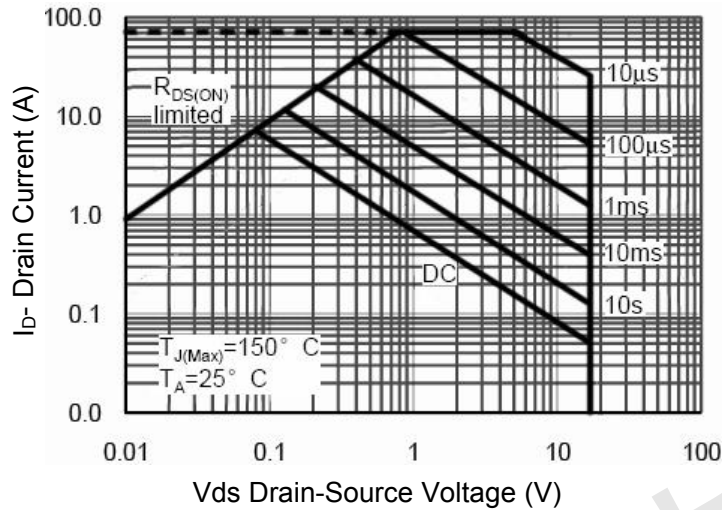

Figure 13 Safe Operation Area

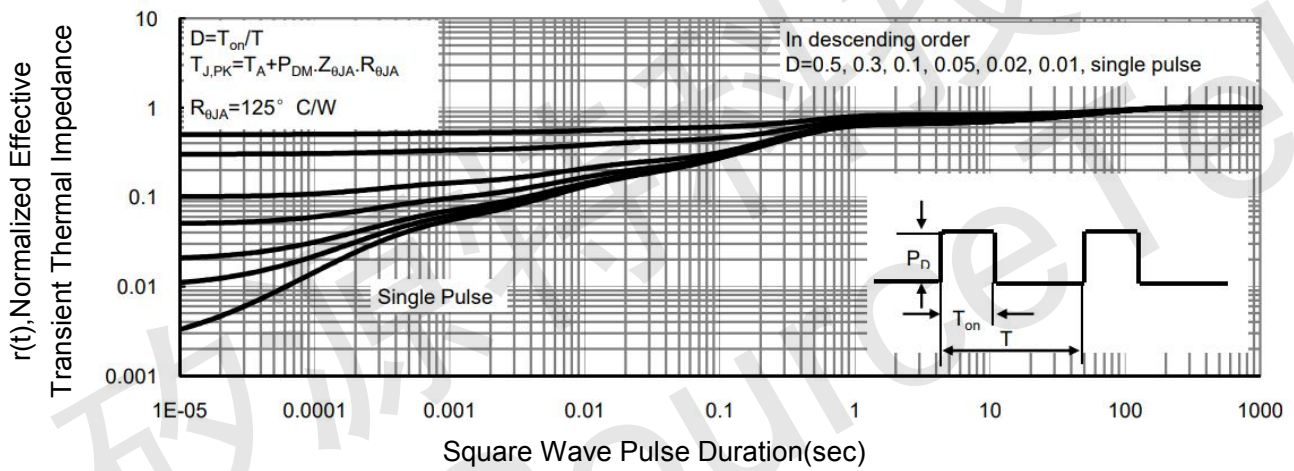
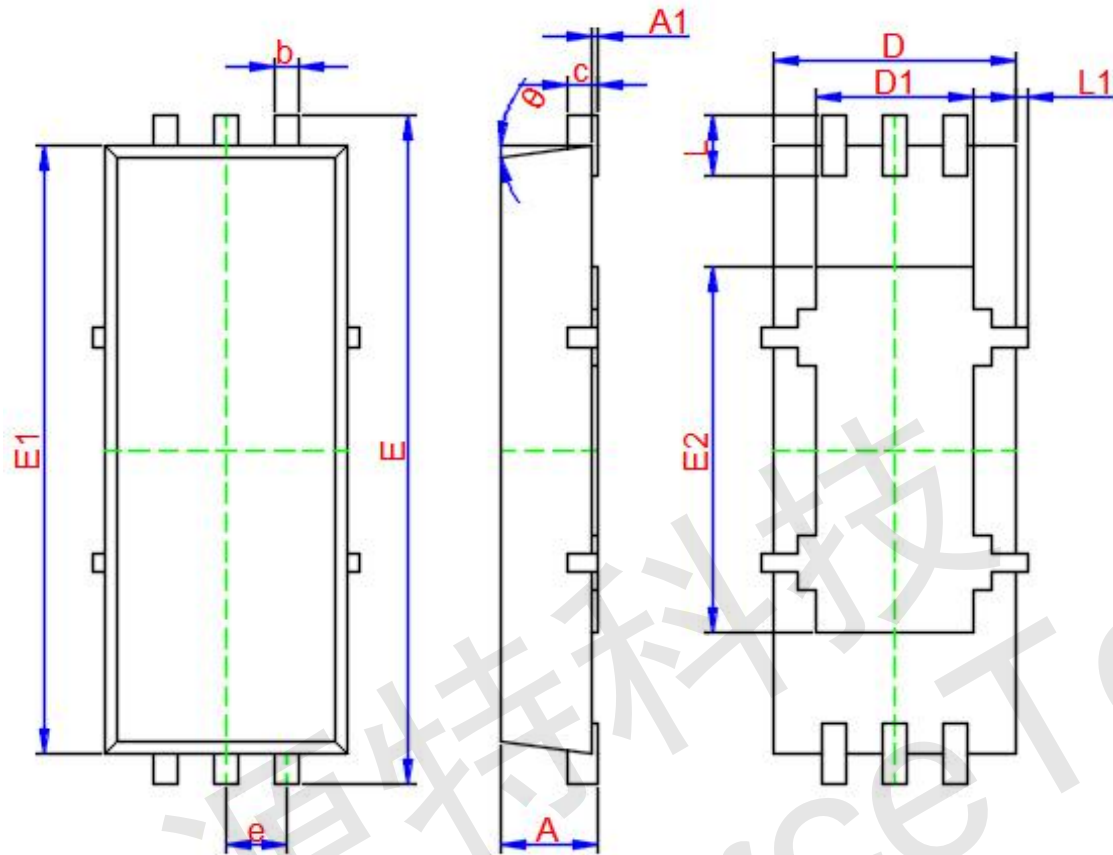

Figure 14 Normalized Maximum Transient Thermal Impedance



PDFN2x5-6L Package Information



Symbol	Dimensions In Millimeters		
	Min.	Typ.	Max.
A	0.700	0.750	0.800
A1	0.000	0.020	0.050
b	0.200	0.225	0.300
c	0.100	0.152	0.200
D	2.000TYP.		
D1	1.300	1.350	1.550
E	5.000TYP		
E1	4.500TYP.		
E2	2.600	2.670	2.950
e	0.500TYP.		
L	0.400	0.500	0.600
L1	0	-	0.100
$\theta$	0°	10°	12°