



N-Channel Enhancement Mode Power MOSFET

Description

The PE8108 uses advanced trench technology to provide excellent $R_{DS(ON)}$ and low gate charge. It can be used in a wide variety of applications.

General Features

- $V_{DS} = 18V$, $I_D = 8A$
- $R_{DS(ON)} < 12m\Omega @ V_{GS}=4.5V$
- $R_{DS(ON)} < 16m\Omega @ V_{GS}=2.5V$
- High Power and current handing capability
- Lead free product is acquired
- Surface Mount Package

Application

- Battery Protection
- Load switch
- Power management

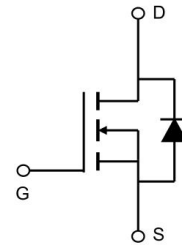

Schematic diagram

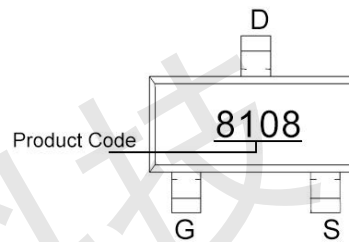

Marking and pin assignment

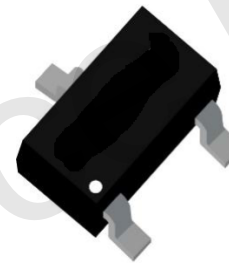

SOT-23-3L

Absolute Maximum Ratings (TA=25°C unless otherwise noted)

| Parameter | Symbol | Rating | Unit |
|--|----------------|------------|------|
| Drain-Source Voltage | V_{DS} | 18 | V |
| Gate-Source Voltage | V_{GS} | ± 12 | V |
| Drain Current-Continuous | I_D | 8 | A |
| Pulsed Drain Current (Note 1) | I_{DM} | 30 | A |
| Maximum Power Dissipation | P_D | 1.7 | W |
| Operating Junction and Storage Temperature Range | T_J, T_{STG} | -55 To 150 | °C |

Thermal Characteristic

| | | | |
|--|-----------------|------|------|
| Thermal Resistance, Junction-to-Ambient (Note 2) | $R_{\theta JA}$ | 73.5 | °C/W |
|--|-----------------|------|------|



Electrical Characteristics (TA=25°C unless otherwise noted)

| Parameter | Symbol | Condition | Min | Typ | Max | Unit |
|---|--------------|--|------|------|-----------|------------|
| Off Characteristics | | | | | | |
| Drain-Source Breakdown Voltage | BV_{DSS} | $V_{GS}=0V, I_D=250\mu A$ | - | 18 | - | V |
| Zero Gate Voltage Drain Current | I_{DSS} | $V_{DS}=16V, V_{GS}=0V$ | - | - | 1 | μA |
| Gate-Body Leakage Current | I_{GSS} | $V_{GS}=\pm 12V, V_{DS}=0V$ | - | - | ± 100 | nA |
| On Characteristics (Note 3) | | | | | | |
| Gate Threshold Voltage | $V_{GS(th)}$ | $V_{DS}=V_{GS}, I_D=250\mu A$ | 0.45 | 0.7 | 0.95 | V |
| Drain-Source On-State Resistance | $R_{DS(on)}$ | $V_{GS}=4.5V, I_D=6A$ | 8.5 | 9 | 12 | m Ω |
| | | $V_{GS}=2.5V, I_D=5.5A$ | 11 | 12.5 | 16 | m Ω |
| Forward Transconductance | g_{FS} | $V_{DS}=5V, I_D=7A$ | - | 18 | - | S |
| Dynamic Characteristics (Note 4) | | | | | | |
| Input Capacitance | C_{iss} | $V_{DS}=10V, V_{GS}=0V,$ $F=1.0MHz$ | - | 830 | - | pF |
| Output Capacitance | C_{oss} | | - | 210 | - | pF |
| Reverse Transfer Capacitance (Note 4) | C_{rss} | | - | 190 | - | pF |
| Switching Characteristics | | | | | | |
| Turn-on Delay Time | $t_{d(on)}$ | $V_{DS}=10V, R_L=1\Omega,$ $V_{GS}=4.5V, R_G=3\Omega$ | - | 6 | - | nS |
| Turn-on Rise Time | t_r | | - | 13 | - | nS |
| Turn-Off Delay Time | $t_{d(off)}$ | | - | 52 | - | nS |
| Turn-Off Fall Time | t_f | | - | 16 | - | nS |
| Total Gate Charge | Q_g | $V_{DS}=10V, I_D=7A,$ $V_{GS}=4.5V$ | - | 15 | - | nC |
| Gate-Source Charge | Q_{gs} | | - | 0.8 | - | nC |
| Gate-Drain Charge | Q_{gd} | | - | 3.6 | - | nC |
| Drain-Source Diode Characteristics | | | | | | |
| Diode Forward Voltage (Note 3) | V_{SD} | $V_{GS}=0V, I_S=1A$ | - | - | 1.2 | V |
| Diode Forward Current (Note 2) | I_S | | - | - | 2.5 | A |

Notes:

1. Repetitive Rating: Pulse width limited by maximum junction temperature.
2. Surface Mounted on FR4 Board, $t \leq 10$ sec.
3. Pulse Test: Pulse Width $\leq 300\mu s$, Duty Cycle $\leq 2\%$.
4. Guaranteed by design, not subject to product.



Typical Electrical and Thermal Characteristics

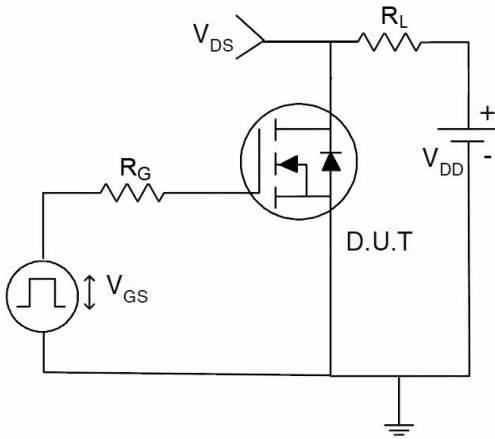

Figure 1 Switching Test Circuit

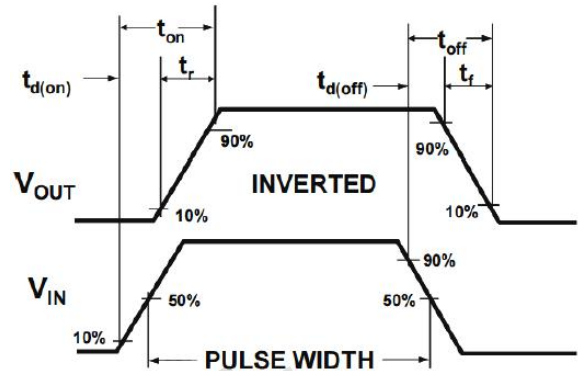

Figure 2 Switching Waveform

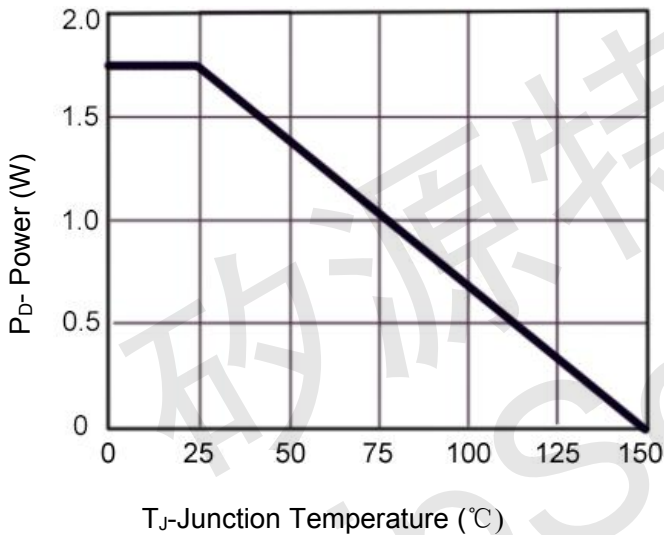

Figure 3 Power Dissipation

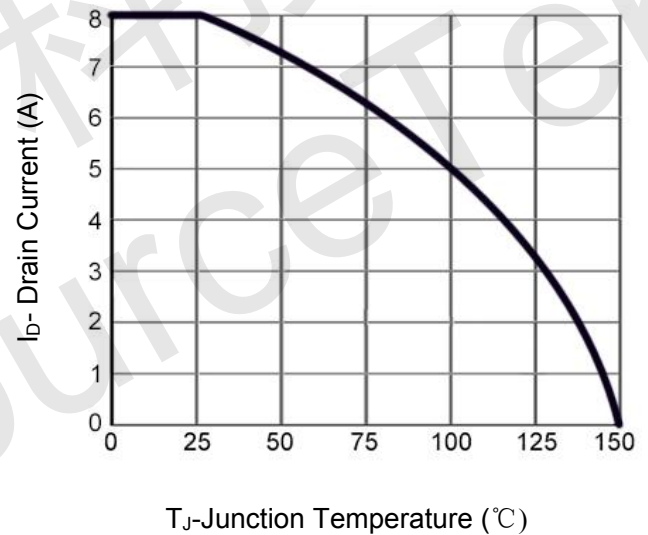

Figure 4 Drain Current

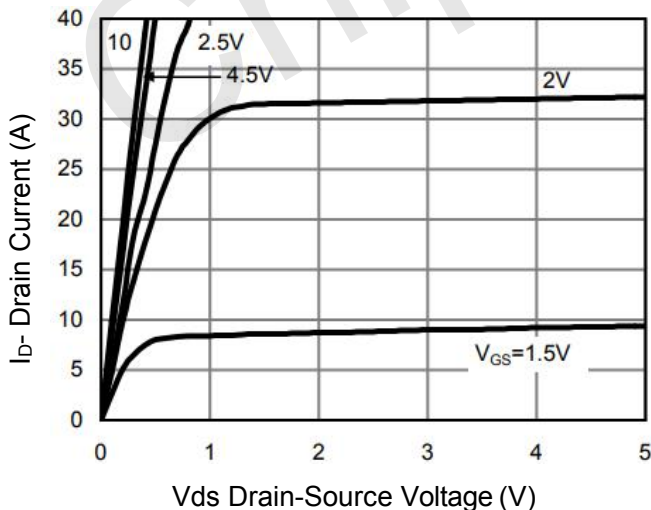

Figure 5 Output Characteristics

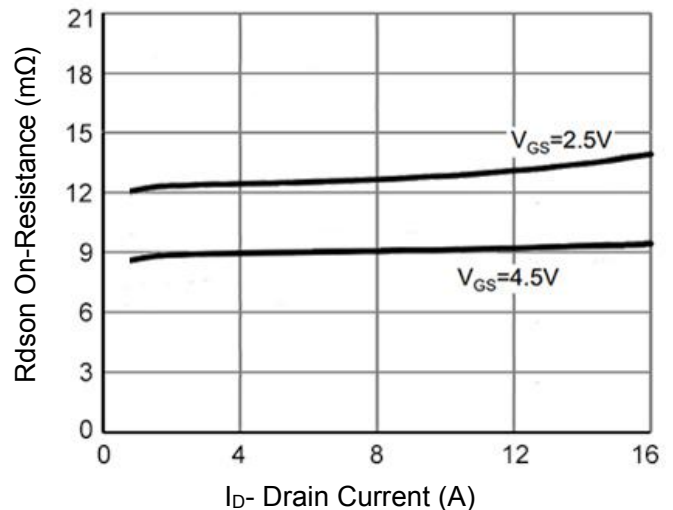

Figure 6 Rdson vs Drain Current

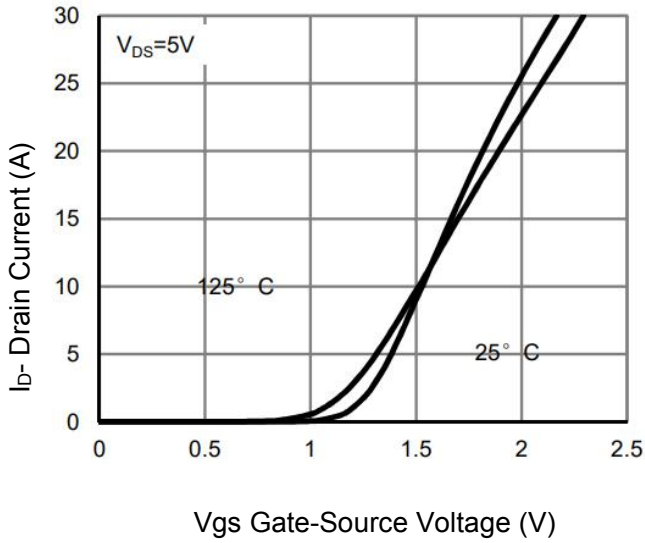

Figure 7 Transfer Characteristics

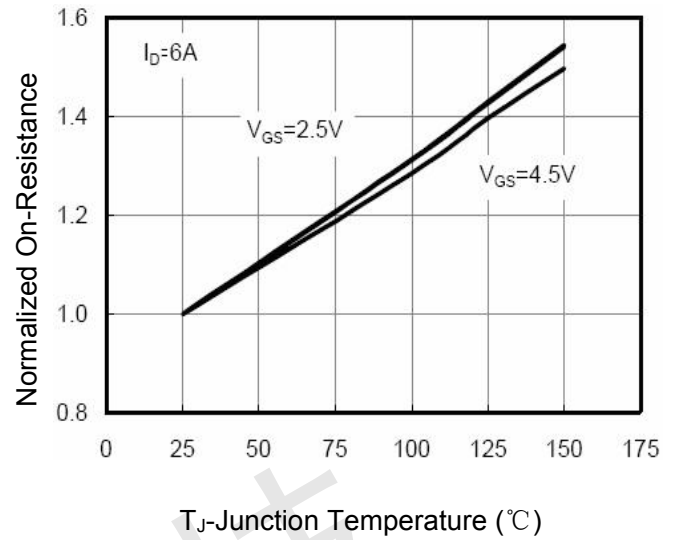

Figure 8 R_{dson} vs Junction Temperature

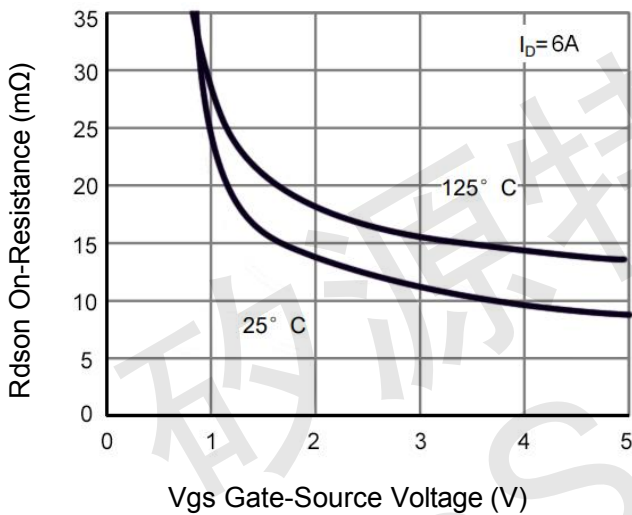

Figure 9 R_{dson} vs V_{GS}

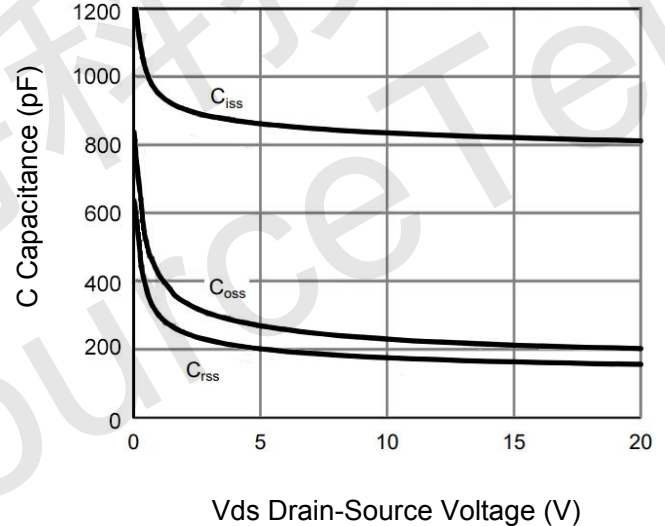

Figure 10 Capacitance vs V_{DS}

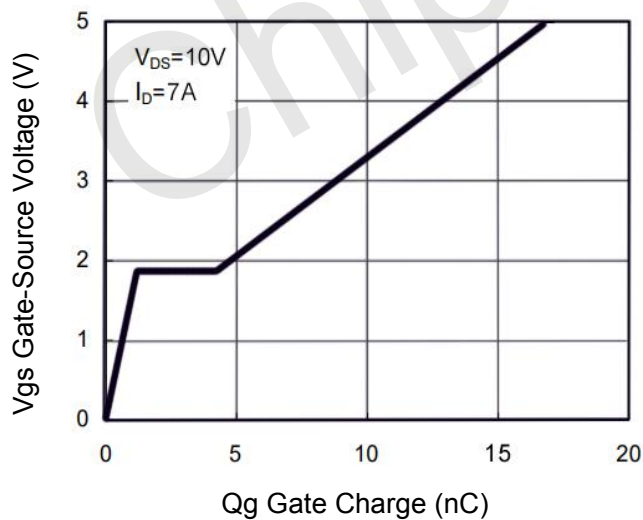

Figure 11 Gate Charge

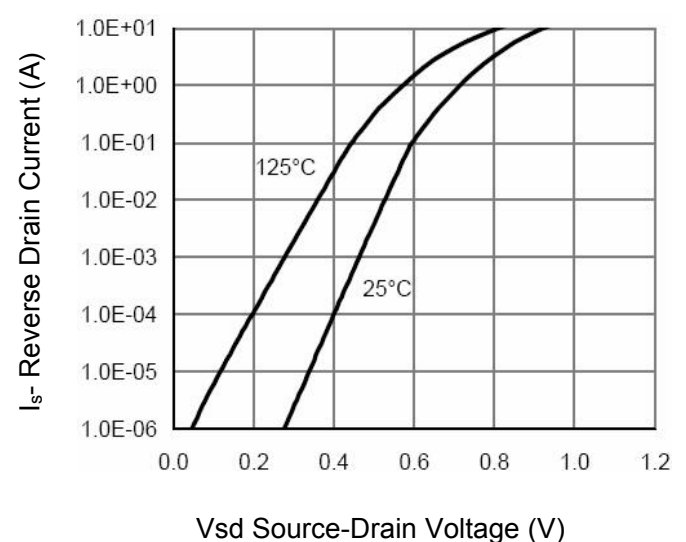

Figure 12 Source- Drain Diode Forward

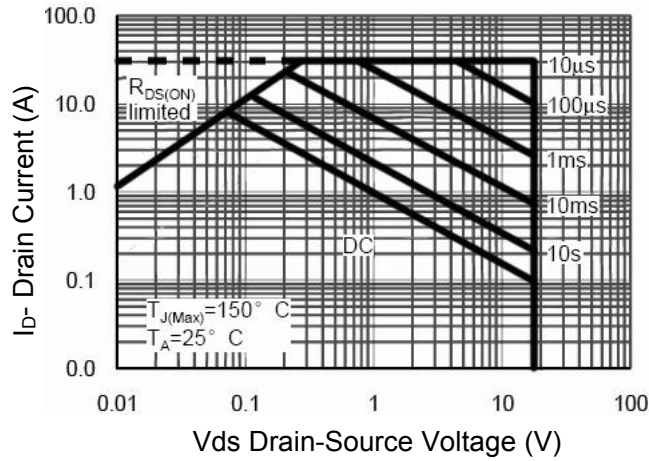

Figure 13 Safe Operation Area

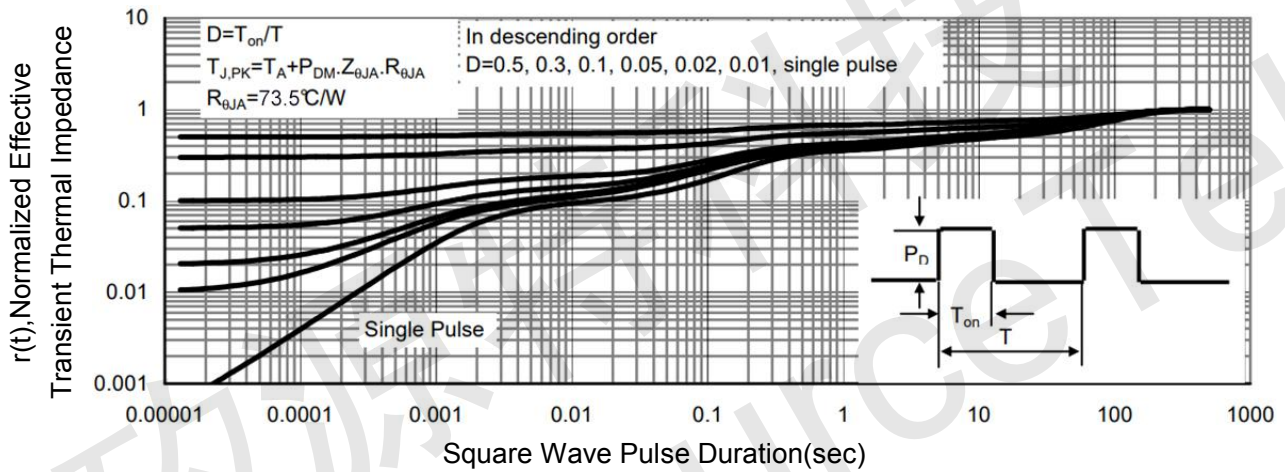
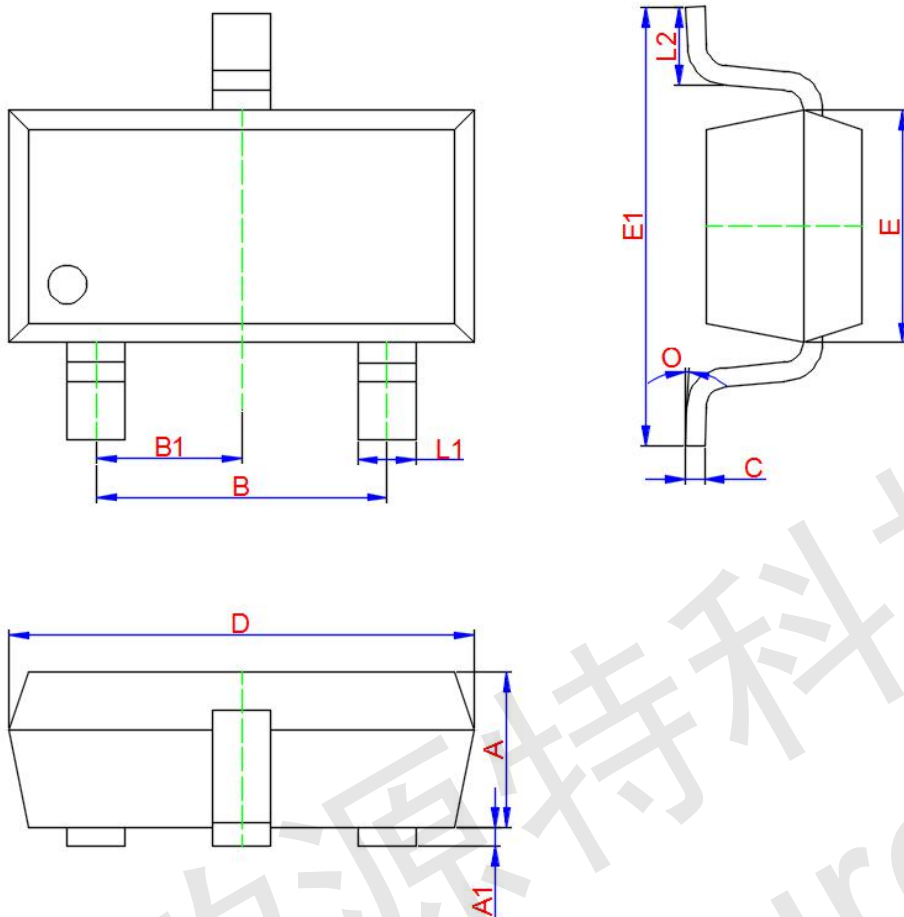

Figure 14 Normalized Maximum Transient Thermal Impedance



SOT-23-3L Package Information



| Symbol | Dimensions In Millimeters | | |
|--------|---------------------------|-------|-------|
| | Min. | Typ. | Max. |
| A | 1.050 | 1.100 | 1.150 |
| A1 | 0.000 | 0.050 | 0.100 |
| L1 | 0.300 | 0.400 | 0.500 |
| C | 0.100 | 0.150 | 0.200 |
| D | 2.820 | 2.920 | 3.020 |
| E | 1.500 | 1.600 | 1.700 |
| E1 | 2.650 | 2.800 | 2.950 |
| B | 1.800 | 1.900 | 2.000 |
| B1 | 0.950 TYP. | | |
| L2 | 0.300 | 0.450 | 0.600 |
| O | 0° | 4° | 8° |