



N-Channel Enhancement Mode Power MOSFET

Description

The PE8203A uses advanced trench technology to provide excellent $R_{DS(ON)}$ and low gate charge. It can be used in a wide variety of applications.

General Features

- $V_{DS} = 18V$, $I_D = 7A$

$$R_{DS(ON)} < 24m\Omega @ V_{GS}=4.5V$$

$$R_{DS(ON)} < 25m\Omega @ V_{GS}=3.8V$$

$$R_{DS(ON)} < 32m\Omega @ V_{GS}=2.5V$$

- High Power and current handling capability
- Lead free product is acquired
- Surface Mount Package

Application

- Battery Protection
- Load switch

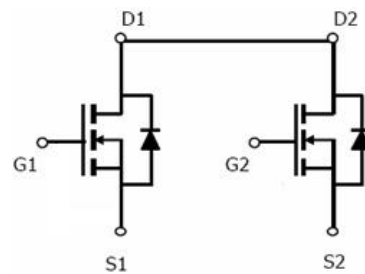

Schematic diagram

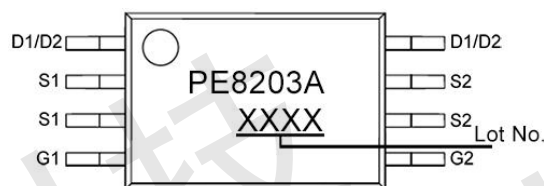

Marking and pin assignment

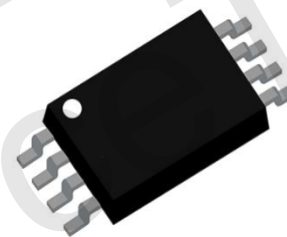

TSSOP-8

Absolute Maximum Ratings (TA=25°C unless otherwise noted)

Parameter	Symbol	Rating	Unit
Drain-Source Voltage	V_{DS}	18	V
Gate-Source Voltage	V_{GS}	± 12	V
Drain Current-Continuous	I_D	7	A
Pulsed Drain Current (Note 1)	I_{DM}	30	A
Maximum Power Dissipation	P_D	1.5	W
Operating Junction and Storage Temperature Range	T_J, T_{STG}	-55 To 150	°C

Thermal Characteristic

Thermal Resistance, Junction-to-Ambient (Note 2)	$R_{\theta JA}$	83	°C/W
--	-----------------	----	------



Electrical Characteristics (TA=25°C unless otherwise noted)

Parameter	Symbol	Condition	Min	Typ	Max	Unit
Off Characteristics						
Drain-Source Breakdown Voltage	BV_{DSS}	$V_{GS}=0V, I_D=250\mu A$	-	18	-	V
Zero Gate Voltage Drain Current	I_{DSS}	$V_{DS}=16V, V_{GS}=0V$	-	-	1	μA
Gate-Body Leakage Current	I_{GSS}	$V_{GS}=\pm 12V, V_{DS}=0V$	-	-	± 100	nA
On Characteristics (Note 3)						
Gate Threshold Voltage	$V_{GS(th)}$	$V_{DS}=V_{GS}, I_D=250\mu A$	0.45	0.7	1.1	V
Drain-Source On-State Resistance	$R_{DS(on)}$	$V_{GS}=4.5V, I_D=6A$	17	18	24	m Ω
		$V_{GS}=3.8V, I_D=5A$	17.5	19	25	m Ω
		$V_{GS}=2.5V, I_D=4A$	21	24	32	m Ω
Forward Transconductance	g_{FS}	$V_{DS}=5V, I_D=5A$	-	10	-	S
Dynamic Characteristics (Note 4)						
Input Capacitance	C_{iss}	$V_{DS}=10V, V_{GS}=0V,$ $F=1.0MHz$	-	710	-	pF
Output Capacitance	C_{oss}		-	346	-	pF
Reverse Transfer Capacitance (Note 4)	C_{rss}		-	160	-	pF
Switching Characteristics						
Turn-on Delay Time	$t_{d(on)}$	$V_{DD}=10V, I_D=1A,$ $V_{GS}=4.5V, R_{GEN}=6\Omega$	-	12	-	nS
Turn-on Rise Time	t_r		-	16	-	nS
Turn-Off Delay Time	$t_{d(off)}$		-	52	-	nS
Turn-Off Fall Time	t_f		-	44	-	nS
Total Gate Charge	Q_g	$V_{DS}=10V, I_D=6A,$ $V_{GS}=4.5V$	-	11	-	nC
Gate-Source Charge	Q_{gs}		-	1.7	-	nC
Gate-Drain Charge	Q_{gd}		-	2.7	-	nC
Drain-Source Diode Characteristics						
Diode Forward Voltage (Note 3)	V_{SD}	$V_{GS}=0V, I_S=1A$	-	-	1.2	V
Diode Forward Current (Note 2)	I_S		-	-	1.7	A

Notes:

1. Repetitive Rating: Pulse width limited by maximum junction temperature.
2. Surface Mounted on FR4 Board, $t \leq 10$ sec.
3. Pulse Test: Pulse Width $\leq 300\mu s$, Duty Cycle $\leq 2\%$.
4. Guaranteed by design, not subject to product.



Typical Electrical and Thermal Characteristics



Figure 1 Switching Test Circuit



Figure 2 Switching Waveform

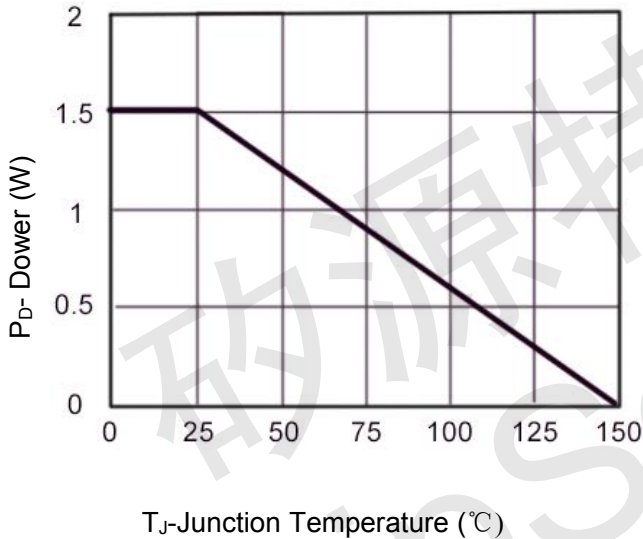

Figure 3 Power Dissipation

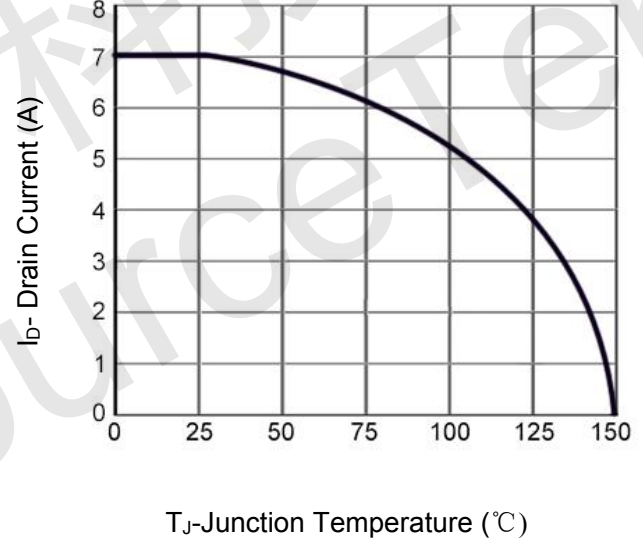

Figure 4 Drain Current

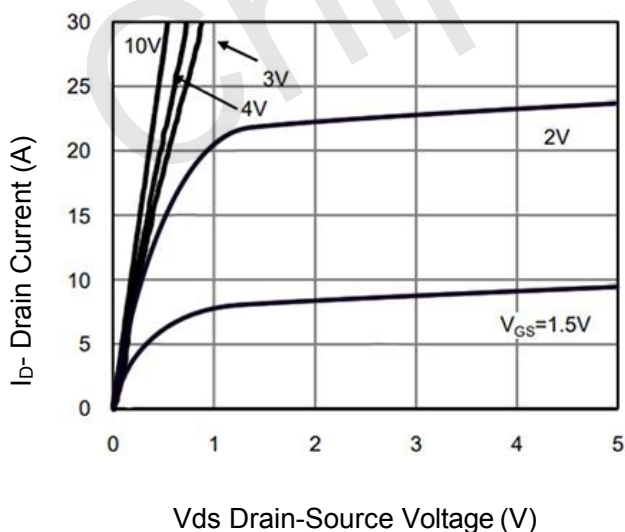

Figure 5 Output Characteristics

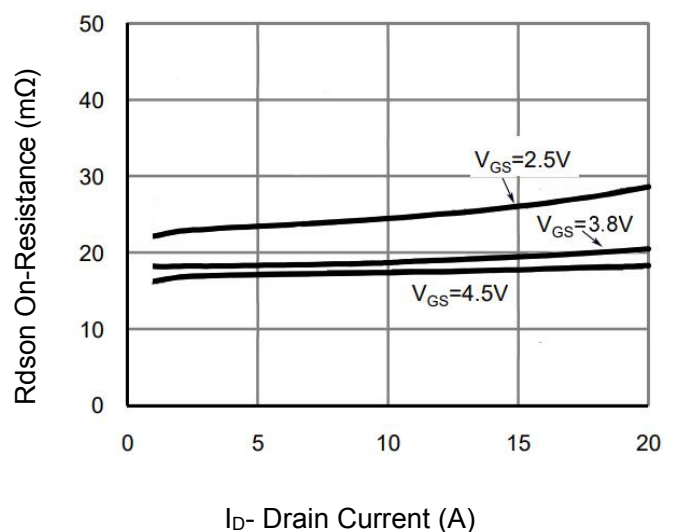

Figure 6 R_{dson} vs Drain Current

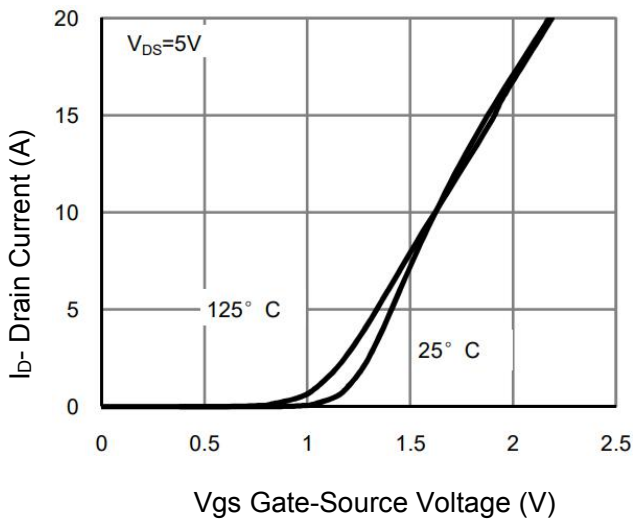

Figure 7 Transfer Characteristics

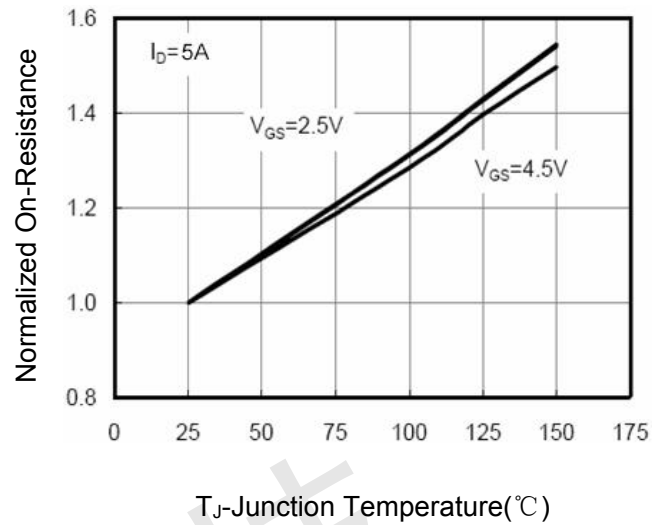

Figure 8 Rdson vs Junction Temperature

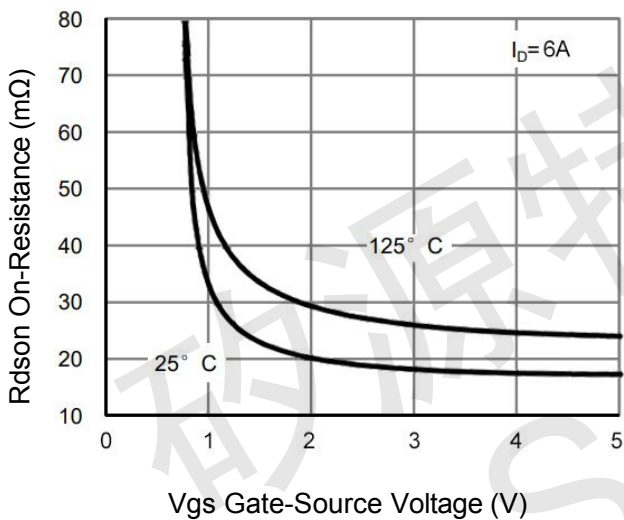

Figure 9 Rdson vs Vgs

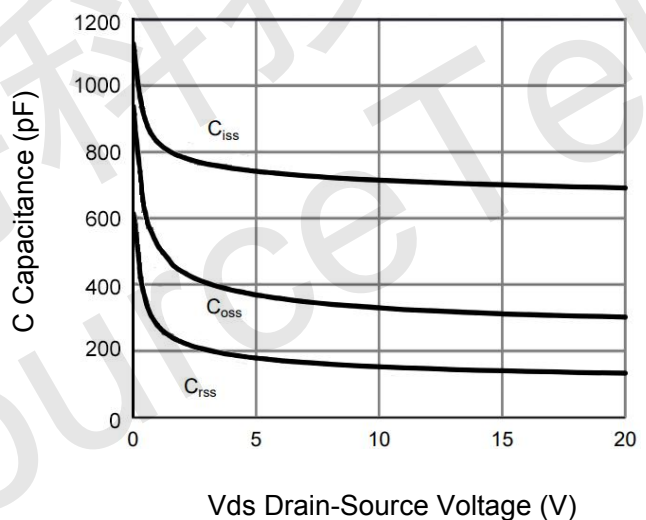

Figure 10 Capacitance vs Vds

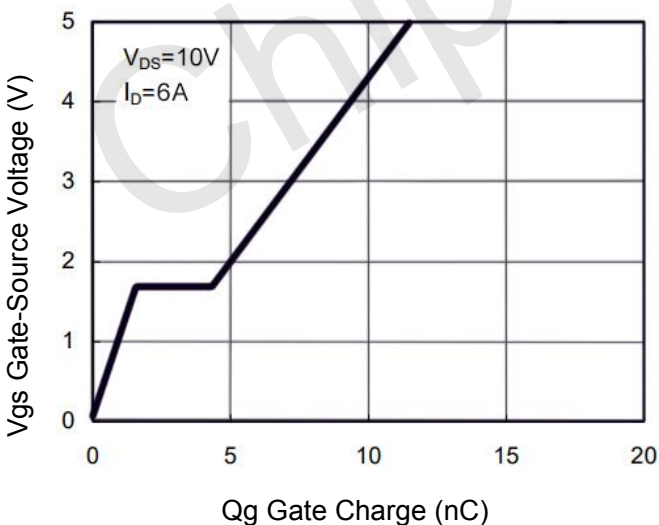

Figure 11 Gate Charge

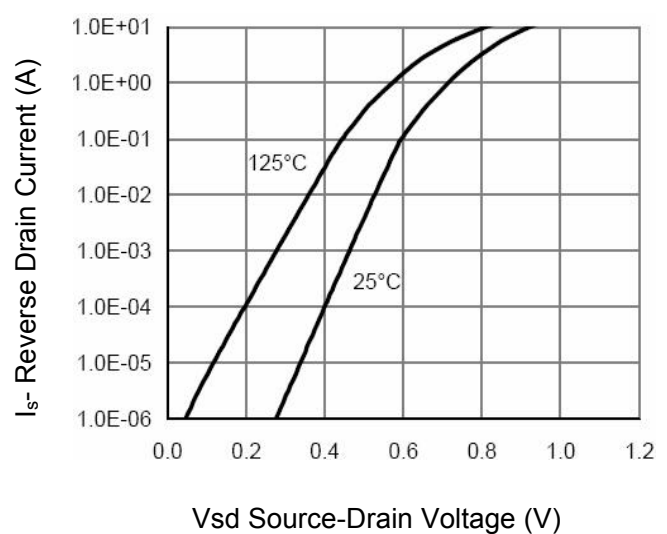

Figure 12 Source- Drain Diode Forward

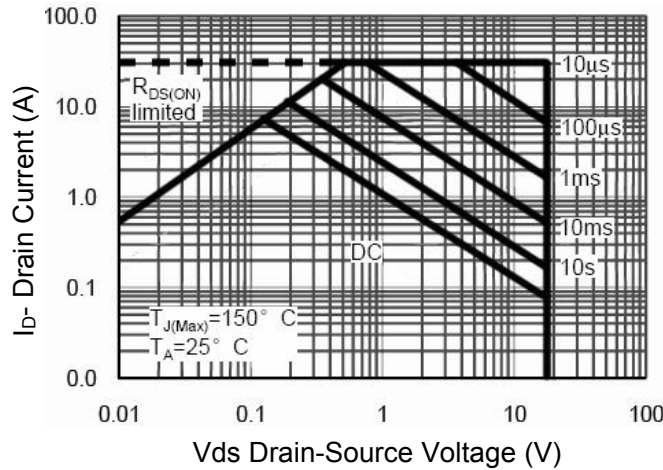

Figure 13 Safe Operation Area

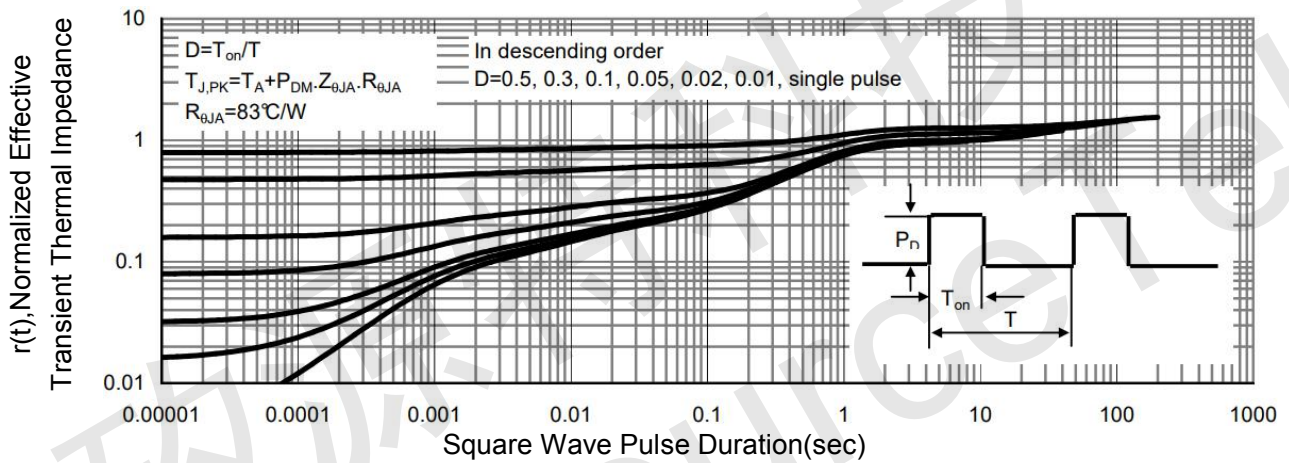
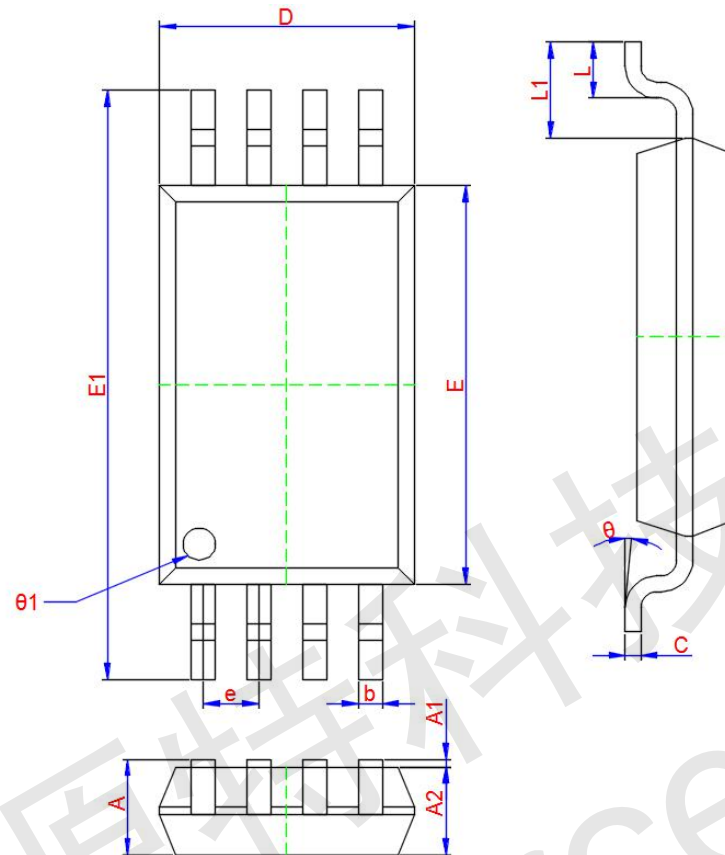

Figure 14 Normalized Maximum Transient Thermal Impedance



TSSOP-8 Package Information



Symbol	Dimensions In Millimeters		
	Min.	Typ.	Max.
A	1.000	1.150	1.200
A1	0.020	0.100	0.180
A2	0.900	1.000	1.100
b	0.170	0.220	0.270
c	0.122	0.127	0.132
L	0.400	0.600	0.800
D	2.870	2.970	3.070
E	4.300	4.400	4.500
E1	6.200	6.400	6.600
$\Theta 1$	0.500	0.600	0.700
Θ	0°	5°	10°
L1	1.00TYP		
e	0.65TYP		